



천조코퍼레이션
CHUNJO CORPORATION

KOBELCO

7120



CHUNJO Corporation

9F Jung Woo B/D, 1111, Chunhodaero, Gangdong-gu,
Seoul, Republic of Korea 05544

Tel : 82-2-489-3438

Fax : 82-2-489-3439

www.chunjo.com

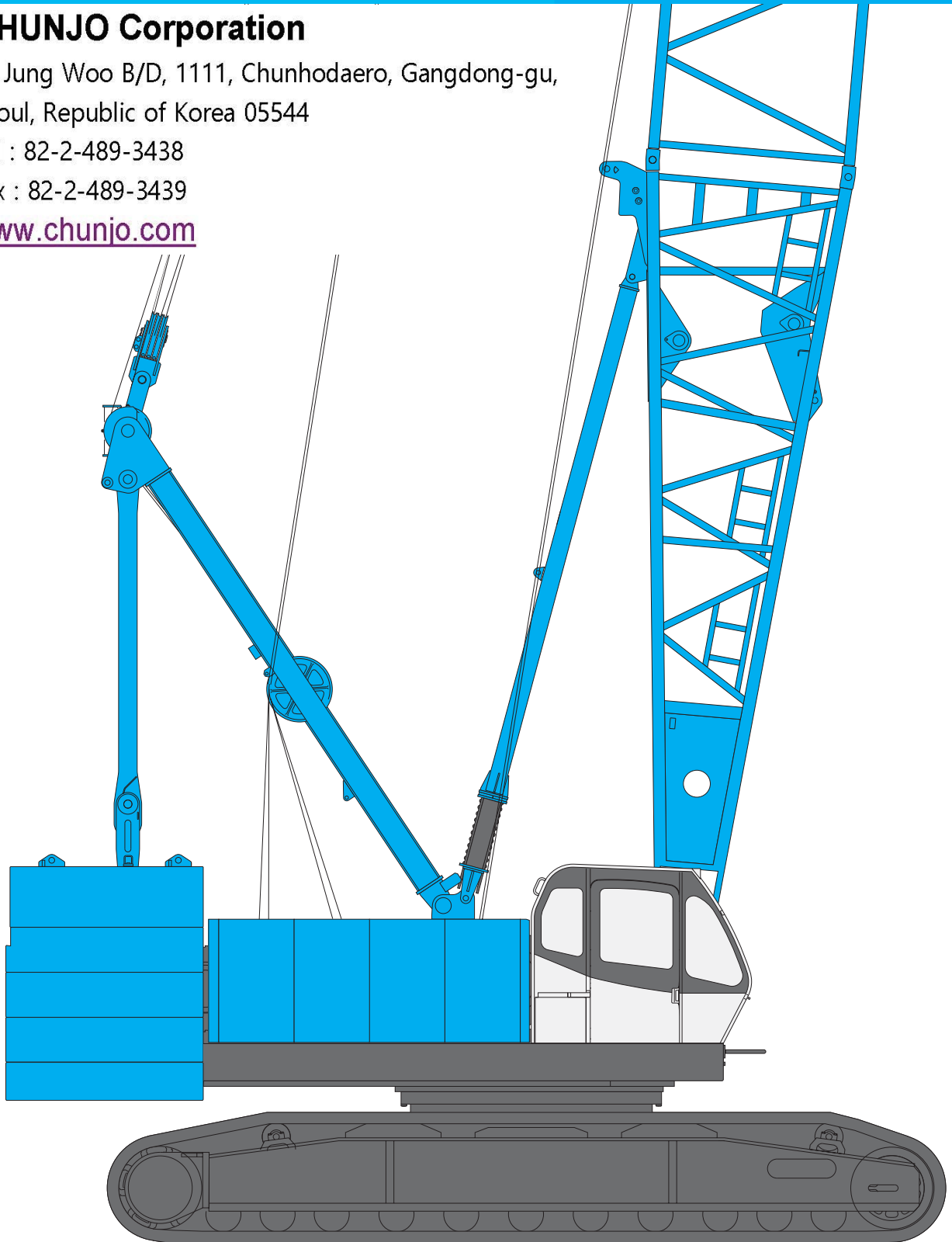

Max. Lifting Capacity: 120 t x 5.0 m
Max. Boom Length: 61.0 m
Max. Long Boom Length: 79.2 m
Max. Jib Combination: 61.0 + 30.5 m
Max. Luffing Tower Combination: 51.7 + 44.2 m

CONFIGURATION

Main Boom

Max. Lifting Capacity:
120 metric ton x 5.0 m
Max. Boom Length:
61.0 m

Long Boom

Max. Lifting Capacity:
24.0 metric ton x 16.0 m
Max. Boom Length:
79.2 m

Fixed Jib

Max. Lifting Capacity:
12.0 metric ton x 30.0 m
Max. Boom Length:
61.0 m + 30.5 m

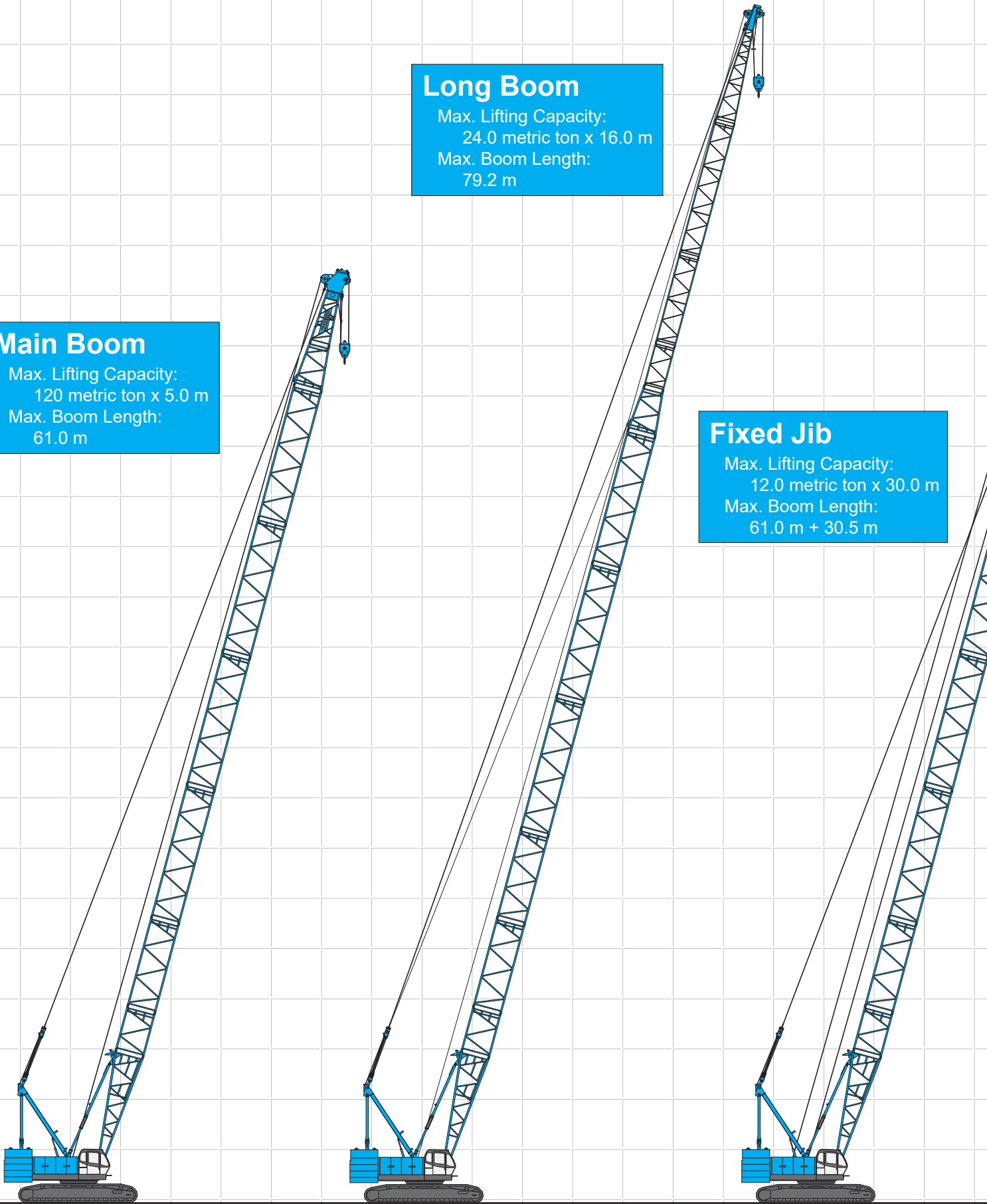

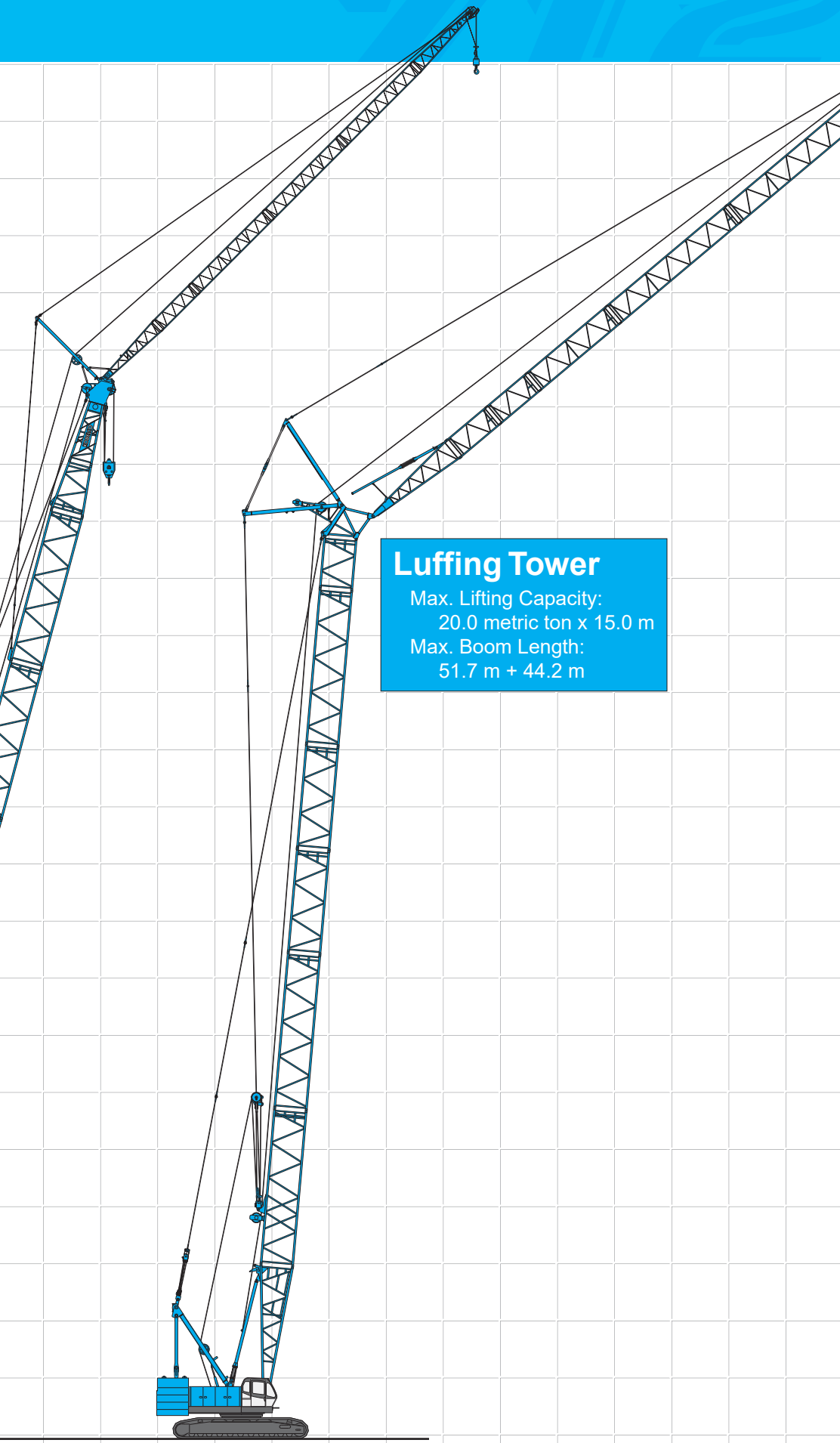

Luffing Tower
 Max. Lifting Capacity:
 20.0 metric ton x 15.0 m
 Max. Boom Length:
 51.7 m + 44.2 m

CONTENTS

- Configuration 1
- Specifications 3
- General Dimensions 5
- Boom and Jib Arrangements**
- Main Boom Arrangements 7
- Fixed Jib Arrangements 7
- Long Boom Arrangements 8
- Luffing Tower Arrangements 9
- Working Ranges and Lifting Capacities**
- Main Boom Working Ranges 11
- Main Boom Lifting Capacity 12
- Auxiliary Sheave Lifting Capacity 13
- Long Boom Working Ranges 14
- Long Boom Lifting Capacities 15
- Fixed Jib Working Ranges 16
- Fixed Jib Lifting capacities 17
- Luffing Tower Working Ranges 19
- Luffing Tower Lifting Capacities 21
- Clamshell 27
- Parts and Attachments ... 28

SPECIFICATIONS



Power Plant

Model: Mitsubishi diesel engine 6D24-TLE2A (JPN)
Type: Water-cooled, direct fuel injection, with turbocharger
Complies with NRMM (Europe) Tier II and US EPA Tier II.
Displacement: 11.945 liters
Rated Power: 235 kW at 2,000 min⁻¹ (rpm) (JIS D0006)
Max. torque: 1,245 N·m/1,400 min⁻¹
Cooling system: Liquid, recirculating bypass
Starter: 24 V/7.0 kW
Radiator: Corrugated type core, thermostatically controlled
Air cleaner: Dry type with replaceable paper element
Throttle: Electric throttle control, twist grip type
Fuel filter: Heavy duty with spin off type cartridge
Batteries: Two 12V - 136 Ah capacity batteries, series connected.
Fuel tank capacity: 400 liters



Hydraulic System

Four variable displacement piston pumps are driven by heavy-duty pump drive. Two of variable displacement pumps are used in the main hook hoist circuit, auxiliary hook hoist circuit, third hoist circuit and each propel circuit. One of the other two pumps is used in the boom hoist circuit, and the other is used in the swing circuit.

Control: Full-flow hydraulic control system for infinitely variable pressure to front and rear drums, boom hoist brakes and clutches. Controls respond instantly to the touch, delivering smooth function operation.

Cooling: Oil-to-air heat exchanger (plate-fin type)

Filtration: Full-flow and bypass type with replaceable paper element

Electrical system: All wiring corded for easy servicing, individual fused branch circuits.

Max. relief valve pressure:

Load hoist, boom hoist and propel system:

30.9 MPa (315 kgf/cm²)

Swing system: 27.5 MPa (280 kgf/cm²)

Control system: 5.6 MPa (55 kgf/cm²)

Reservoir capacity: 520 liters



Boom Hoisting System

Powered by a hydraulic motor through a planetary reducer.

Brake: A spring-set, hydraulically released multiple-disc brake is mounted on the boom hoist motor and operated through a counter-balance valve.

Drum lock: External ratchet for locking drum.

Drum: Double drum, grooved for 20 mm dia. wire rope.

Line speed: Double line on first drum layer

Hoisting/Lowering: 48 to 2 m/min

Diameter of wire ropes

Boom guy line: 30 mm

Boom hoist reeving: 12 parts of 20 mm dia. high strength wire rope

Boom backstops: Required for all boom lengths



Load Hoist System

Front and rear drums for load hoist powered by a hydraulic variable plunger motors, driven through planetary reducers.

Negative Brake: A spring-set, hydraulically released multiple-disc brake is mounted on the hoist motor and operated through a counter-balance valve. (Positive free fall brake is optional item.)

Drum lock: External ratchet for locking drum.

Drums:

Front drum:

617.1 mm P.C.D. x 554 mm wide drum, grooved for 26 mm wire rope. Rope capacity is 270 m working length and 350 m storage length.

Rear drum:

617.1 mm P.C.D. x 554 mm wide drum, grooved for 26 mm wire rope. Rope capacity is 250 m working length and 350 m storage length.

Note: Rope lengths listed above denote drum capacity and may differ from actual rope lengths supplied when machinery is shipped.

Line speed: Single line on the first drum layer

Hoisting/Lowering: 120 to 3 m/min

Line Pull (Single-line):

Rated line pull: 118 kN (12.0 tf)



Swing System

Swing unit is powered by hydraulic motor driving spur gears through planetary reducers (2 sets), the swing system provides 360° rotation.

Swing brakes: A spring-set, hydraulically released multiple-disc brake is mounted on swing motor.

Swing circle: Single-row ball bearing with an integral internally cut swing gear.

Swing lock: Manually, four position lock for transportation

Swing speed: 2.1 min⁻¹ (rpm)



Upper Structure

Torsion-free precision machined upper frame. All components are located clearly and service friendly. Engine with low noise level.

Counterweight: 52.3 t



Cab & Control

Totally enclosed, full vision cab with safety glass, fully adjustable, high backed seat with a head-rest and armrests, and intermittent wiper and window washer (roof, front and lower front window).

Cab fittings:

Air conditioner, convenient compartment (for tool), cup holder, ashtray, cigarette lighter, sun visor, roof blind, tinted glass, floor mat, foot-rest, shoe tray

Controls:

Four hand levers for front and rear drum, swing and boom drum controls



Lower Structure

Steel-welded carbody with axles. Crawler assemblies are designed with quick disconnect feature for individual removal as a unit from axles. Crawler belt tension is maintained by hydraulic jack force on the track-adjusting bearing block.

Crawler drive: Independent hydraulic propel drive is built into each crawler side frame. Each drive consists of a hydraulic motor propelling a driving tumbler through a planetary gear box. Hydraulic motor and gear box are built into the crawler side frame within the shoe width.

Crawler brakes: Spring-set, hydraulically released parking brakes are built into each propel drive.

Steering mechanism: A hydraulic propel system provides both skid steering (driving one track only) and counter-rotating steering (driving each track in opposite directions).

Track rollers: Sealed track rollers for maintenance-free operation.

Shoes (flat): 60 shoes, 910 mm wide each crawler

Max. travel speed: 1.3/0.9 km/h

Max. gradeability: 30%



Weight

Including upper and lower machine, 52.3 ton counterweight basic boom (or basic tower + basic jib), hook, and other accessories.

Specification	Weight	Ground pressure
Main boom	Approx. 120 ton,	94 kPa (0.96 kgf/cm ²)
Luffing Tower	Approx. 130 ton,	102 kPa (1.04 kgf/cm ²)



Attachment

Boom and Jib:

Welded lattice construction using tubular, high-tensile steel chords with pin connections between sections.

Boom Length

	Main Boom	Long Boom	Luffing Tower
Basic Boom	15.2 m	61.0 m	30.4 m
Max. Boom	61.0 m	79.2 m	51.7 m

Jib Length

	Fixed Jib	Luffing Jib
Basic Jib	12.2 m	22.9 m
Max. Jib	30.5 m	44.2 m

Max. Combination (Boom + Jib)

Main Boom	61.0 m (boom only)
Long Boom	79.2 m (boom only)
Fixed Jib	61.0 m + 30.5 m
Luffing Tower	51.7 m + 44.2 m

Main Specifications (Model: 7120)

Main Boom	
Max. Lifting Capacity	120 t/5.0 m
Max. Length	61.0 m
Long Boom	
Max. Lifting Capacity	24.0 t/16.0 m
Max. Length	79.2 m
Fixed Jib	
Max. Lifting Capacity	12.0 t/30.0 m
Max. Combination	61.0 m + 30.5 m
Luffing Tower	
Max. Lifting Capacity	20.0 t/15.0 m
Max. Combination	51.7 m + 44.2 m
Luffing Angle	60° ~ 90°
Main & Aux. Winch	
Max. Line Speed	120 m/min (1st layer)
Rated Line Pull (Single-line)	118 kN (12.0 tf)
Wire Rope	26 mm
Wire Rope Length	270 m (Main) 250 m (Aux.)
Brake Type	Spring set hydraulically released multiple disc brake(Negative)
Free-Fall	Option

Working Speed

Swing Speed	2.1 min ⁻¹ (rpm)
Travel Speed	1.3/0.9 km/h

Power Plant

Model	Mitsubishi 6D24-TLE2A
Engine Output	235 kW/2,000 min ⁻¹
Fuel Tank Capacity	400 liters

Hydraulic System

Main Pumps	4 variable displacement
Max. Pressure	30.9 MPa (315 kgf/cm ²)
Hydraulic Tank Capacity	520 liters

Weight

Operating Weight*	Approx. 120 t
Ground Pressure*	94 kPa (0.96 kgf/cm ²)
Counterweight	52.3 t
Transport Weight**	36,785 t (Base machine)

* Including upper and lower machine, 52.3 ton counterweight, basic boom, hook, and other accessories.

** Base machine with gantry, lower boom, carbody, lower spreader and upper spreader.

GENERAL DIMENSIONS

Main Boom

(Unit: mm)

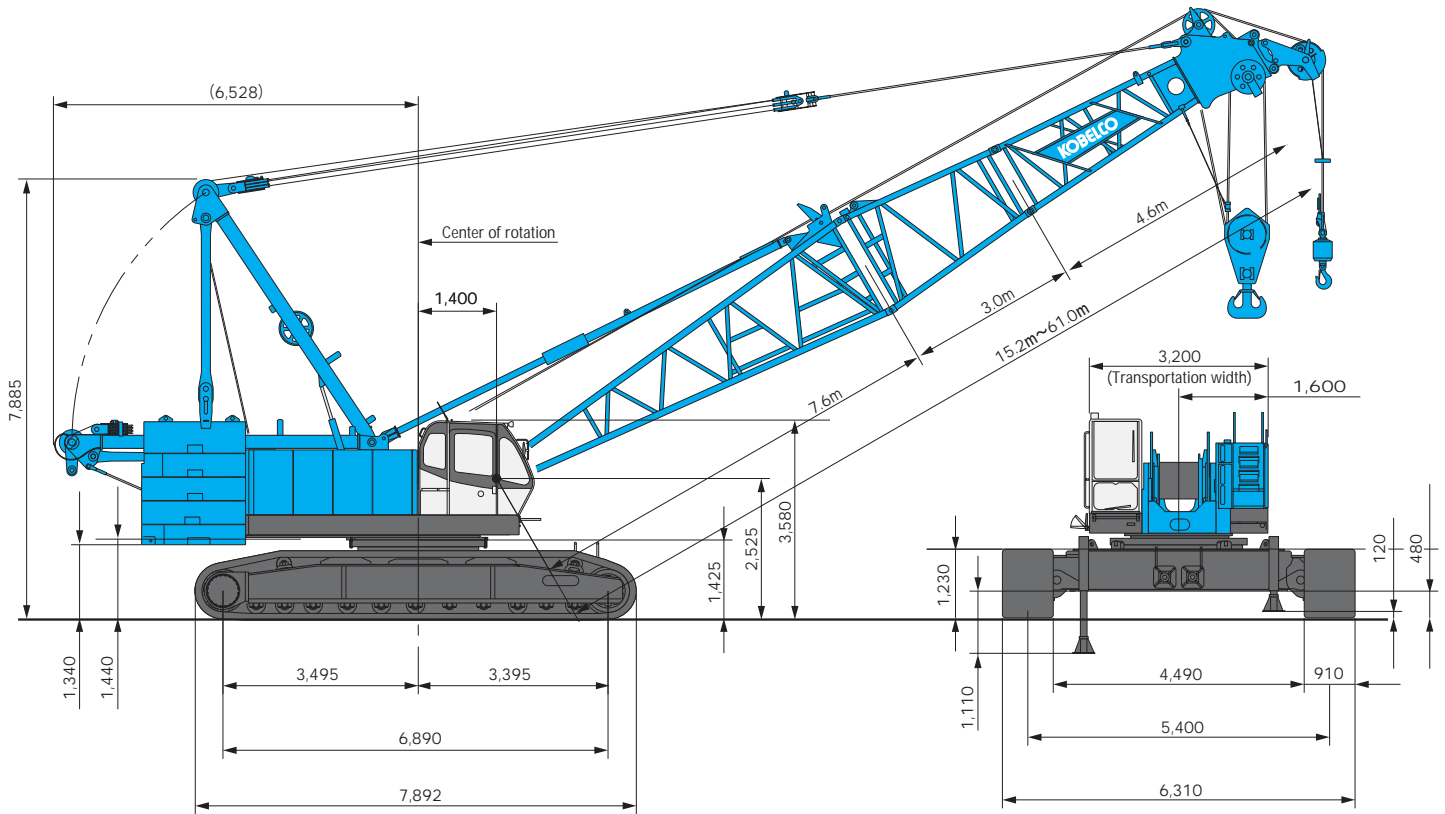

Limit of Hook Lifting

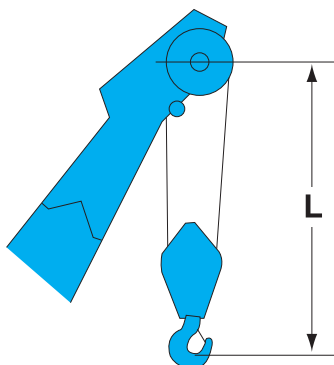

Hook	L
120 t hook	5.0 m
70 t hook	5.0 m
35 t hook	5.0 m

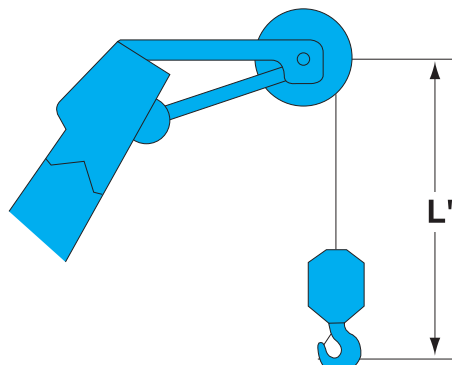

Hook	L'
12 t ball hook	4.2 m

Luffing Tower

(Unit: mm)

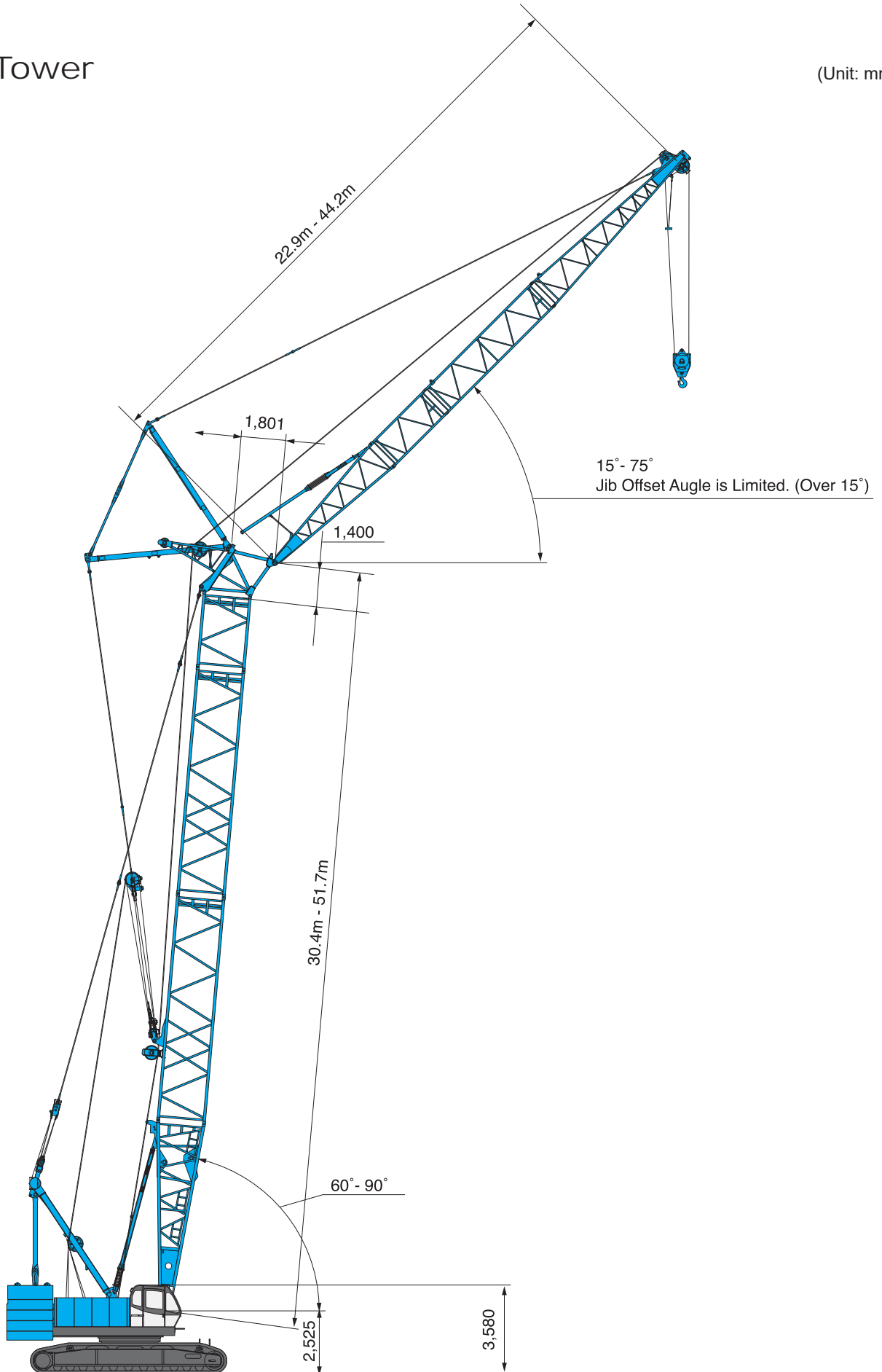

BOOM AND JIB ARRANGEMENTS

Main Boom Arrangements

Boom length m (ft)	Boom arrangement
15.2 (50)	
18.3 (60)	
21.3 (70)	
24.4 (80)	
27.4 (90)	
30.5 (100)	
33.5 (110)	
36.6 (120)	
39.6 (130)	

Boom length m (ft)	Boom arrangement
42.7 (140)	
45.7 (150)	
48.8 (160)	
51.8 (170)	
54.9 (180)	
57.9 (190)	
61.0 (200)	

Symbol	Boom Length	Remarks
	7.6 m	Boom Base
	4.6 m	Boom Top
	3.0 m	Tapered Boom
	3.0 m	Insert Boom
	6.1 m	Insert Boom
	9.1 m	Insert Boom

↗ mark shows the guy line installing position when the fixed jib is used.

※ mark shows the standard boom arrangement which enables each boom length of less than that boom length to be configured.

Fixed Jib Arrangements

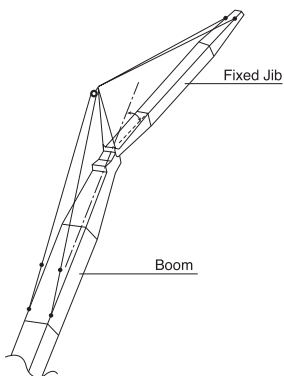

Jib length m (ft)	Jib arrangement
12.2(40)	
18.3 (60)	
24.4 (80)	
30.5 (100)	

Symbol	Jib Length	Remarks
	4.6 m	Jib Base
	4.6 m	Jib Top
	3.0 m	Insert Jib
	6.1 m	Insert Jib

Long Boom Arrangements

Boom length m (ft)	Long Boom arrangement
61.0 (200)	
64.0 (210)	※
67.1 (220)	※
70.1 (230)	
73.2 (240)	※
76.2 (250)	
79.2 (260)	

Symbol	Luffing Boom Length	Remarks
	7.6 m	Boom Base
	7.6 m	Tower Jib Top
	3.0 m	Insert Boom
	6.1 m	Insert Boom
	9.1 m	Insert Boom
	3.0 m	Tapered Boom
	3.0 m	Relay Jib
	3.0 m	Insert Jib
	6.1 m	Insert Jib
	9.1 m	Insert Jib

※ mark shows the standard boom arrangement which enables each boom length of less than that boom length to be configured.

Luffing Tower Arrangements

Tower Jib Arrangements

Tower length m (ft)	Boom arrangement
30.4 (100)	
33.4 (110)	
36.5 (120)	
39.5 (130)	
42.5 (140)	
45.6 (150)	
48.6 (160)	
51.7 (170)	

Jib length m (ft)	Jib arrangement
22.9 (75)	
25.9 (85)	
29.0 (95)	
32.0 (105)	
35.1 (115)	
38.1 (125)	
41.1 (135)	
44.2 (145)	

Symbol	Luffing Tower Length	Remarks
	7.6 m	Boom Base
	1.4 m	Tower Cap
	3.0 m	Insert Boom
	6.1 m	Insert Boom
	9.1 m	Insert Boom
	9.1 m	Special Insert Boom for Tower

Symbol	Luffing Jib Length	Remarks
	6.1 m	Tower Jib Base
	7.6 m	Tower Jib Top
	3.0 m	Relay Jib
	3.0 m	Tower Insert Jib
	6.1 m	Tower Insert Jib
	9.1 m	Tower Insert Jib

※ mark shows the standard luffing jib arrangement which enables each luffing jib length of less than that jib length to be configured.

○ mark indicates position where cable rollers attached

- ※ mark shows the standard luffing jib arrangement which enables each luffing jib length of less than that jib length to be configured.
- 9.1A may also be used as insert boom for crawler crane.
 - For 9.1 m insert boom with lug must not be used for insert tower boom used next to tower cap.

Tower and Jib Combinations and Allowable Tower Angle

Jib Length (m) \ Tower Length (m)	22.9	25.9	29.0	32.0	35.1	38.1	41.1	44.2	Pillow plate
30.4	90°-60°	90°-60°	—	—	—	—	—	—	—
33.4	90°-60°	90°-60°	90°-60°	90°-60°	—	—	—	—	—
36.5	90°-60°	90°-60°	90°-60°	90°-60°	—	—	—	—	—
39.5	90°-60°	90°-60°	90°-60°	90°-60°	90°-60°	—	—	—	—
42.5	90°-60°	90°-60°	90°-60°	90°-60°	90°-60°	90°-60°	—	—	—
45.6	90°-60°	90°-60°	90°-60°	90°-60°	90°-60°	90°-60°	90°-70°	—	—
48.6	90°-60°	90°-60°	90°-60°	90°-60°	90°-60°	90°-70°	90°-70°	90°-70°	—
51.7	90°-60°	90°-60°	90°-60°	90°-60°	90°-70°	90°-70°	90°-70°	90°-70°	Need
Hook									
35-ton hook	○	○	○	○	○	○	○	○	
Ball hook	×	○	○	○	○	○	○	○	



Hook Blocks

A range of hook blocks can be specified, each with a safety latch.

Hooks	Weight (kg)	No. of sheaves	No. of lines and max. rated loads (tons)				
			1	2	3	4	5
120-ton	1,700	5			36.0	48.0	60.0
70-ton	1,200	3		24.0	35.0	48.0	60.0
35-ton	900	1		24.0			
12-ton ball hook	450	0	12.0				

Hooks	Weight (kg)	No. of sheaves	No. of lines and max. rated loads (tons)				
			6	7	8	9	10
120-ton	1,700	5	72.0	84.0	96.0	108.0	120.0
70-ton	1,200	3	70.0				
35-ton	900	1					
12-ton ball hook	450	0					

WORKING RANGES AND LIFTING CAPACITIES

Main Boom Working Ranges

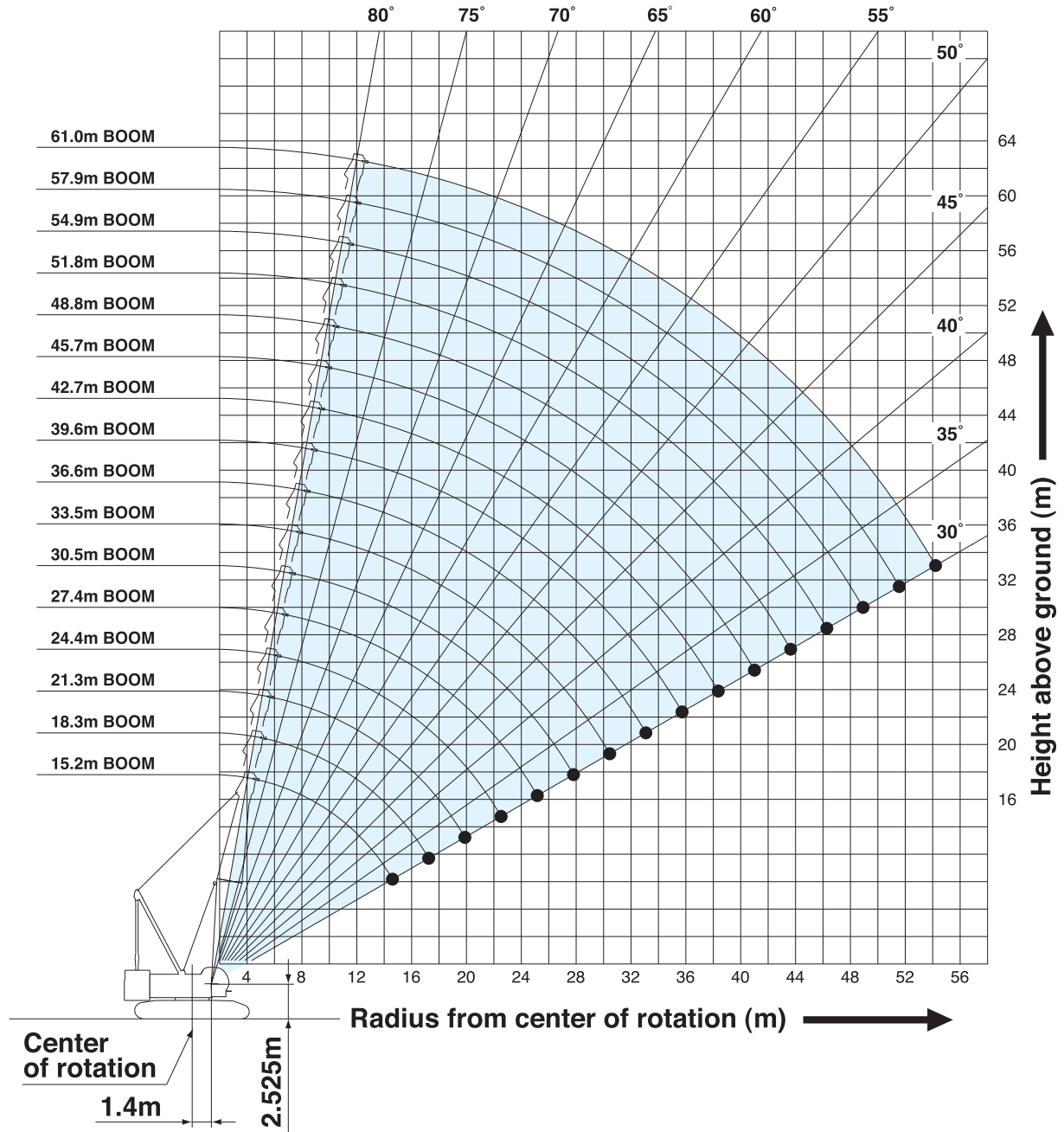

NOTES:

1. Ratings according to Japanese Construction Codes for Mobile Cranes and Japanese Safety Ordinance on Cranes, etc.
2. Ratings in metric tons for 360° working area.
3. Operating radius is the horizontal distance from center of rotation to a vertical line through the center of gravity of the load.
4. Deduct weight of main hook block, slings and all other load handling accessories from main boom or auxiliary sheave ratings shown.
5. Ratings shown are based on freely suspended loads and make no allowance for such factors as wind effect on lifted load, ground conditions out-of-level, operating speeds or any other condition that could be detrimental to the safe operation of this equipment. Operator, therefore, has the responsibility to judge the existing conditions and reduce lifted loads and operating speeds accordingly.
6. Ratings are for operation on a firm and level surface, up to 1% gradient.
7. At radii and boom lengths where no ratings are shown on chart, operation is not intended nor approved.
8. Boom inserts and guy lines must be arranged as shown in the "Operator's Manual".
9. Boom hoist reeving is 12 part line.
10. Gantry must be in raised position for all conditions.
11. Boom backstops are required for all boom lengths.
12. Ratings shown in [] are determined by the strength of the boom or other structural component.
13. Instruction in the "Operator's Manual" must be strictly observed when operating the machine.
14. Main boom ratings: Deduct weight of main hook block, slings, and all other load handling accessories from main boom ratings shown.
15. Auxiliary sheave ratings: Deduct weight of ball hook, slings, and all other load handling accessories from auxiliary sheave ratings shown. Boom lengths for auxiliary sheave mounting are 15.2 m to 61.0 m.

Main Boom Lifting Capacity

Unit: metric ton

Counterweight: 52.3 t

Working radius (m) \ Boom Length (m)	15.2	18.3	21.3	24.4	27.4	30.5	33.5	36.6	39.6	42.7	45.7	48.8	Boom Length (m) \ Working radius (m)
4.5	4.5 m/120.0												4.5
5.0	120.0	5.1 m/108.0	5.6 m/96.0										5.0
6.0	100.0	99.8	94.9	6.1 m/84.0	6.7 m/74.6								6.0
7.0	85.7	85.5	85.3	81.5	73.7	7.2 m/66.4	7.7 m/59.4						7.0
8.0	73.7	73.6	73.5	73.5	71.3	64.7	58.9	8.2 m/53.6	8.8 m/48.0				8.0
9.0	61.5	61.3	61.2	61.1	61.0	60.9	57.2	52.5	48.0	9.3 m/43.5	9.8 m/39.6		9.0
10.0	52.6	52.5	52.3	52.2	52.1	52.0	52.0	51.2	46.8	42.8	39.5	10.4 m/36.0	10.0
12.0	40.6	40.5	40.3	40.2	40.0	40.0	39.9	39.7	39.7	39.5	37.8	34.7	12.0
14.0	33.0	32.8	32.6	32.5	32.3	32.3	32.2	32.0	31.9	31.8	31.6	31.6	14.0
16.0	14.9 m/29.1	27.5	27.3	27.2	26.9	26.9	26.8	26.6	26.5	26.4	26.2	26.1	16.0
18.0		17.5 m/24.5	23.3	23.2	23.0	22.9	22.8	22.6	22.5	22.4	22.2	22.1	18.0
20.0			20.3	20.2	20.0	19.9	19.8	19.5	19.5	19.3	19.1	19.1	20.0
22.0			20.1 m/20.2	17.8	17.6	17.5	17.4	17.1	17.1	16.9	16.7	16.6	22.0
24.0				22.8 m/17.1	15.6	15.5	15.4	15.2	15.1	14.9	14.7	14.7	24.0
26.0					25.4 m/14.5	13.9	13.8	13.6	13.5	13.3	13.1	13.0	26.0
28.0						12.6	12.5	12.2	12.1	12.0	11.7	11.7	28.0
30.0							11.3	11.1	11.0	10.8	10.6	10.5	30.0
32.0							30.7 m/11.0	10.1	10.0	9.8	9.6	9.5	32.0
34.0								33.3 m/9.5	9.1	8.9	8.7	8.6	34.0
36.0									8.4	8.2	8.0	7.9	36.0
38.0										7.5	7.3	7.2	38.0
40.0										38.6 m/7.4	6.7	6.6	40.0
42.0											41.2 m/6.4	6.1	42.0
44.0												43.9 m/5.6	44.0
Reeves	10	9	8	7	7	6	5	5	4	4	4	3	Reeves

Working radius (m) \ Boom Length (m)	51.8	54.9	57.9	61.0	Boom Length (m) \ Working radius (m)
10.0	10.9 m/32.1	11.4 m/29.4			10.0
12.0	31.4	29.0	26.9	12.5 m/24.0	12.0
14.0	30.1	27.9	25.9	23.5	14.0
16.0	26.0	25.8	24.9	22.8	16.0
18.0	22.0	21.8	21.6	21.4	18.0
20.0	18.9	18.7	18.6	18.5	20.0
22.0	16.5	16.3	16.1	16.0	22.0
24.0	14.5	14.3	14.1	14.1	24.0
26.0	12.9	12.7	12.5	12.4	26.0
28.0	11.5	11.3	11.1	11.0	28.0
30.0	10.3	10.1	10.0	9.9	30.0
32.0	9.3	9.1	9.0	8.9	32.0
34.0	8.5	8.2	8.1	8.0	34.0
36.0	7.7	7.5	7.3	7.2	36.0
38.0	7.0	6.8	6.6	6.5	38.0
40.0	6.4	6.2	6.0	5.9	40.0
42.0	5.9	5.7	5.5	5.4	42.0
44.0	5.4	5.2	5.0	4.9	44.0
46.0	5.0	4.7	4.6	4.4	46.0
48.0	48.5 m/4.9	4.3	4.1	3.9	48.0
50.0		49.2 m/4.1	3.7	3.5	50.0
52.0			51.8 m/3.3	3.1	52.0
54.0				2.7	54.0
56.0				54.4 m/2.7	56.0
Reeves	3	3	3	2	Reeves

Note:
 Ratings according to Japanese Construction Codes for Mobile Cranes and Japanese Safety Ordinance on Cranes, etc.
 Ratings shown in are determined by the strength of the boom or other structural components.
 Refer to notes P11.

Auxiliary Sheave Lifting Capacity (Without Main Hook)

Unit: metric ton

Counterweight: 52.3 t

Working radius (m) \ Boom Length (m)	15.2	18.3	21.3	24.4	27.4	30.5	33.5	36.6	39.6	42.7	45.7	Working radius (m) \ Boom Length (m)
4.5												4.5
5.0	12.0/5.3m	12.0/5.8m										5.0
6.0	12.0	12.0	12.0/6.3m	12.0/6.9m								6.0
7.0	12.0	12.0	12.0	12.0	12.0/7.4m	12.0/7.9m						7.0
8.0	12.0	12.0	12.0	12.0	12.0	12.0	12.0/8.4m					8.0
9.0	12.0	12.0	12.0	12.0	12.0	12.0	12.0	12.0	12.0/9.5m			9.0
10.0	12.0	12.0	12.0	12.0	12.0	12.0	12.0	12.0	12.0	12.0	12.0/10.6m	10.0
12.0	12.0	12.0	12.0	12.0	12.0	12.0	12.0	12.0	12.0	12.0	12.0	12.0
14.0	12.0	12.0	12.0	12.0	12.0	12.0	12.0	12.0	12.0	12.0	12.0	12.0
16.0	12.0	12.0	12.0	12.0	12.0	12.0	12.0	12.0	12.0	12.0	12.0	12.0
18.0	12.0/16.2m	12.0	12.0	12.0	12.0	12.0	12.0	12.0	12.0	12.0	12.0	12.0
20.0		12.0/18.8m	12.0	12.0	12.0	12.0	12.0	12.0	12.0	12.0	12.0	12.0
22.0			12.0/21.5m	12.0	12.0	12.0	12.0	12.0	12.0	12.0	12.0	12.0
24.0				12.0	12.0	12.0	12.0	12.0	12.0	12.0	12.0	12.0
26.0				12.0/24.1m	12.0	12.0	12.0	12.0	12.0	12.0	12.0	12.0
28.0					12.0/26.7m	12.0	12.0	11.9	11.8	11.7	11.4	12.0
30.0						12.0/29.4m	11.0	10.8	10.7	10.5	10.3	12.0
32.0							10.1	9.8	9.7	9.5	9.3	12.0
34.0								8.9	8.8	8.6	8.4	12.0
36.0								8.6/34.7m	8.1	7.9	7.7	12.0
38.0									7.6/37.3m	7.2	7.0	12.0
40.0										6.9/39.9m	6.4	12.0
42.0											5.9	12.0
44.0											5.8/42.6m	12.0
Reeves	1	1	1	1	1	1	1	1	1	1	1	Reeves

Working radius (m) \ Boom Length (m)	48.8	51.8	54.9	57.9	61.0	Working radius (m) \ Boom Length (m)
10.0	12.0/11.1m	12.0/11.6m				10.0
12.0	12.0	12.0	12.0/12.2m	12.0/12.7m	12.0/13.2m	12.0
14.0	12.0	12.0	12.0	12.0	12.0	14.0
16.0	12.0	12.0	12.0	12.0	12.0	16.0
18.0	12.0	12.0	12.0	12.0	12.0	18.0
20.0	12.0	12.0	12.0	12.0	12.0	20.0
22.0	12.0	12.0	12.0	12.0	12.0	22.0
24.0	12.0	12.0	12.0	12.0	12.0	24.0
26.0	12.0	12.0	12.0	12.0	12.0	26.0
28.0	11.4	11.2	11.0	10.8	10.7	28.0
30.0	10.2	10.0	9.8	9.7	9.6	30.0
32.0	9.2	9.0	8.8	8.7	8.6	32.0
34.0	8.3	8.2	7.9	7.8	7.7	34.0
36.0	7.6	7.4	7.2	7.0	6.9	36.0
38.0	6.9	6.7	6.5	6.3	6.2	38.0
40.0	6.3	6.1	5.9	5.7	5.6	40.0
42.0	5.8	5.6	5.4	5.2	5.1	42.0
44.0	5.3	5.1	4.9	4.7	4.6	44.0
46.0	5.0/45.2m	4.7	4.4	4.3	4.1	46.0
48.0		4.3/47.9m	4.0	3.8	3.6	48.0
50.0			3.7	3.4	3.2	50.0
52.0			3.6/50.5m	3.0	2.8	52.0
54.0				2.7/53.1m	2.4	54.0
56.0					2.0/55.8m	56.0
Reeves	1	1	1	1	1	Reeves

Note:

Ratings according to Japanese Construction Codes for Mobile Cranes and Japanese Safety Ordinance on Cranes, etc.

Ratings shown in are determined by the strength of the boom or other structural components.

Refer to notes P11.

Long Boom Working Ranges

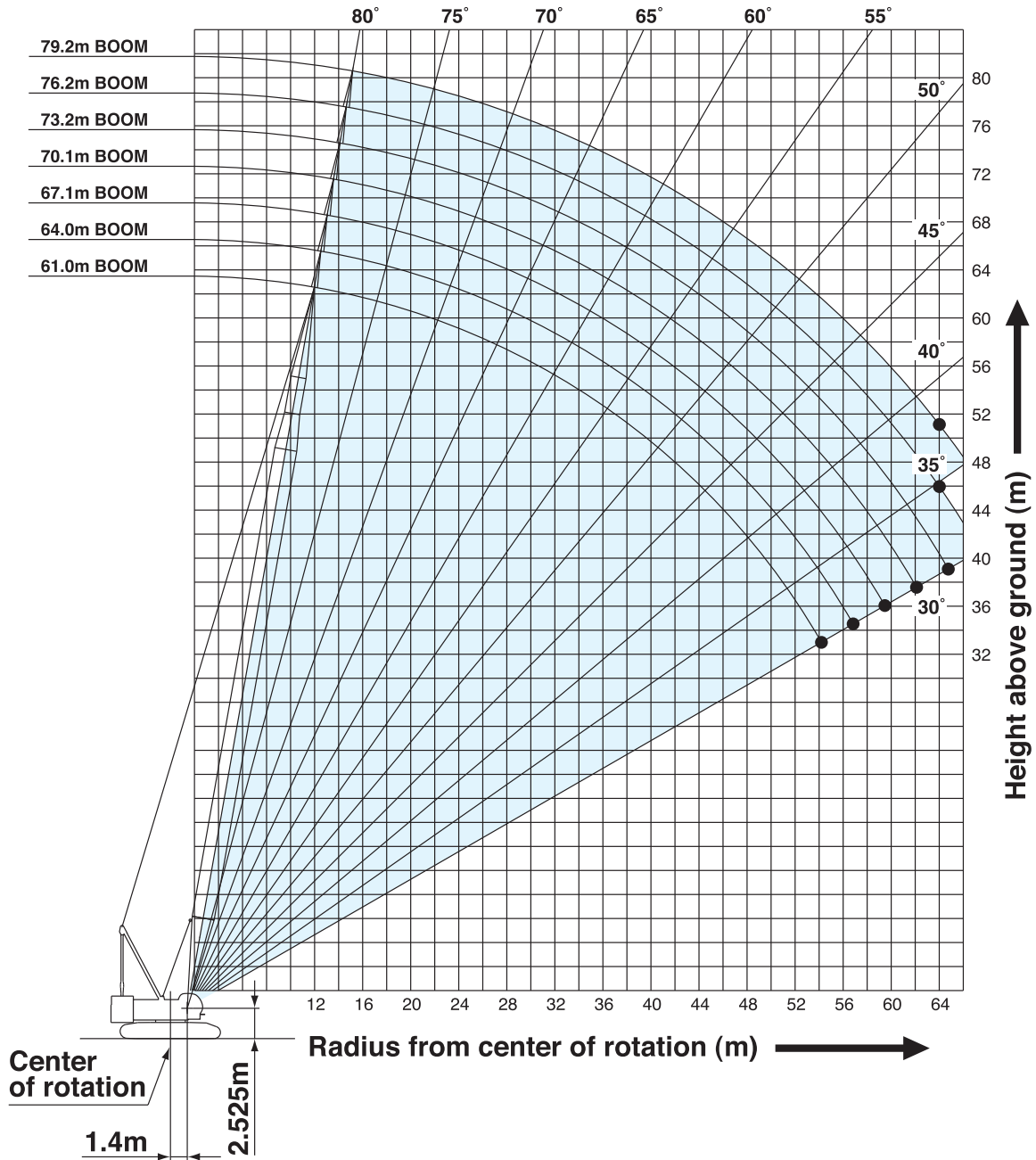

NOTES:

1. Ratings according to Japanese Construction Codes for Mobile Cranes and Japanese Safety Ordinance on Cranes, etc.
2. Ratings in metric tons for 360° working area.
3. Operating radius is the horizontal distance from center of rotation to a vertical line through the center of gravity of the load.
4. Deduct weight of main hook block, slings and all other load handling accessories from long boom or auxiliary sheave ratings shown.
5. Ratings shown are based on freely suspended loads and make no allowance for such factors as wind effect on lifted load, ground conditions out-of-level, operating speeds or any other condition that could be detrimental to the safe operation of this equipment. Operator, therefore, has the responsibility to judge the existing conditions and reduce lifted loads and operating speeds accordingly.
6. Ratings are for operation on a firm and level surface, up to 1% gradient.
7. At radii and boom lengths where no ratings are shown on chart, operation is not intended nor approved.
8. Boom inserts and guy lines must be arranged as shown in the "Operator's Manual".
9. Boom hoist reeving is 12 part line.
10. Gantry must be in raised position for all conditions.
11. Boom backstops are required for all boom lengths.
12. Ratings shown in are determined by the strength of the boom or other structural component.
13. Instruction in the "Operator's Manual" must be strictly observed when operating the machine.
14. Long boom ratings: Deduct weight of main hook block, slings, and all other load handling accessories from long boom ratings shown.
15. Auxiliary sheave ratings: Deduct weight of ball hook, slings, and all other load handling accessories from auxiliary sheave ratings shown. Long boom lengths for auxiliary sheave mounting are 61.0 m to 76.2 m.

Long Boom Lifting Capacity

Unit: metric ton

Counterweight: 52.3 t

Working radius (m) \ Boom Length (m)	61.0	64.0	67.1	70.1	73.2	76.2	79.2	Boom Length (m) \ Working radius (m)
12.0	12.3 m/24.0	12.8m/24.0	13.3 m/24.0	13.9 m/24.0				12.0
14.0	24.0	24.0	24.0	24.0	14.4m/22.1	14.9 m/18.7	15.4 m/16.3	14.0
16.0	24.0	24.0	24.0	24.0	20.9	17.9	15.9	16.0
18.0	22.8	22.6	22.5	22.5	19.5	16.7	14.8	18.0
20.0	19.7	19.5	19.5	19.4	18.3	15.7	13.9	20.0
22.0	17.3	17.1	17.0	17.0	16.9	14.8	13.1	22.0
24.0	15.3	15.1	15.0	15.0	14.9	14.0	12.3	24.0
26.0	13.7	13.5	13.4	13.4	13.3	13.1	11.7	26.0
28.0	12.3	12.1	12.0	12.0	11.9	11.7	11.2	28.0
30.0	11.1	10.9	10.8	10.8	10.7	10.6	10.5	30.0
32.0	10.1	9.9	9.8	9.8	9.7	9.5	9.5	32.0
34.0	9.2	9.0	8.9	8.9	8.8	8.7	8.6	34.0
36.0	8.4	8.3	8.2	8.1	8.0	7.9	7.8	36.0
38.0	7.8	7.6	7.5	7.5	7.4	7.2	7.2	38.0
40.0	7.2	7.0	6.9	6.8	6.7	6.6	6.5	40.0
42.0	6.6	6.4	6.3	6.3	6.2	6.0	6.0	42.0
44.0	6.1	5.9	5.8	5.8	5.7	5.5	5.5	44.0
46.0	5.7	5.5	5.4	5.3	5.2	5.1	5.0	46.0
48.0	5.3	5.1	5.0	4.9	4.8	4.7	4.6	48.0
50.0	4.9	4.7	4.6	4.6	4.5	4.3	4.3	50.0
52.0	4.6	4.4	4.3	4.2	4.1	4.0	3.9	52.0
54.0	4.3	4.1	3.9	3.9	3.8	3.6	3.5	54.0
56.0	54.4m/4.2	3.8	3.7	3.6	3.5	3.3	3.2	56.0
58.0		57.0 m/3.6	3.4	3.3	3.2	2.9	2.9	58.0
60.0			59.7 m/3.1	3.0	2.9	2.6	2.6	60.0
62.0				2.8	2.6	2.4	2.3	62.0
64.0				62.3 m/2.7	2.4	2.1	2.0	64.0
66.0					64.9 m/2.2			66.0
Reeves	2	2	2	2	2	2	2	Reeves

Note:
Ratings according to Japanese Construction Codes for Mobile Cranes and Japanese Safety Ordinance on Cranes, etc.
Ratings shown in are determined by the strength of the boom or other structural components.
Refer to notes P14.

Auxiliary Sheave Lifting Capacity for Long Boom (Without Main Hook)

Unit: metric ton

Counterweight: 52.3 t

Working radius (m) \ Boom Length (m)	61.0	64.0	67.1	70.1	73.2	76.2	Boom Length (m) \ Working radius (m)
12.0	12.9m/12.0	13.4m/12.0					12.0
14.0	12.0	12.0	12.0	14.5m/12.0	15.0m/12.0	15.5m/12.0	14.0
16.0	12.0	12.0	12.0	12.0	12.0	12.0	16.0
18.0	12.0	12.0	12.0	12.0	12.0	12.0	18.0
20.0	12.0	12.0	12.0	12.0	12.0	12.0	20.0
22.0	12.0	12.0	12.0	12.0	12.0	12.0	22.0
24.0	12.0	12.0	12.0	12.0	12.0	12.0	24.0
26.0	12.0	12.0	12.0	12.0	12.0	12.0	26.0
28.0	12.0	11.8	11.7	11.7	11.6	11.4	28.0
30.0	10.8	10.6	10.5	10.5	10.4	10.3	30.0
32.0	9.8	9.6	9.5	9.5	9.4	9.2	32.0
34.0	8.9	8.7	8.6	8.6	8.5	8.4	34.0
36.0	8.1	8.0	7.9	7.8	7.7	7.6	36.0
38.0	7.5	7.3	7.2	7.2	7.1	6.9	38.0
40.0	6.9	6.7	6.6	6.5	6.4	6.3	40.0
42.0	6.3	6.1	6.0	6.0	5.9	5.7	42.0
44.0	5.8	5.6	5.5	5.5	5.4	5.2	44.0
46.0	5.4	5.2	5.1	5.0	4.9	4.8	46.0
48.0	5.0	4.8	4.7	4.6	4.5	4.4	48.0
50.0	4.6	4.4	4.3	4.3	4.2	4.0	50.0
52.0	4.3	4.1	4.0	3.9	3.8	3.7	52.0
54.0	4.0	3.8	3.6	3.6	3.5	3.3	54.0
56.0	55.1m/3.7	3.5	3.4	3.3	3.2	3.0	56.0
58.0		57.8m/3.2	3.1	3.0	2.9	2.6	58.0
60.0			2.8	2.7	2.6	2.3	60.0
62.0			60.4m/2.7	2.5	2.3	2.1	62.0
64.0				63.0m/2.4	2.1		64.0
66.0							66.0
Reeves	2	2	2	2	2	2	Reeves

Note:
Ratings according to Japanese Construction Codes for Mobile Cranes and Japanese Safety Ordinance on Cranes, etc.
Ratings shown in are determined by the strength of the boom or other structural components.
Refer to notes P14.

Fixed Jib Working Ranges

Jib Offset Angle: 10°, 30°

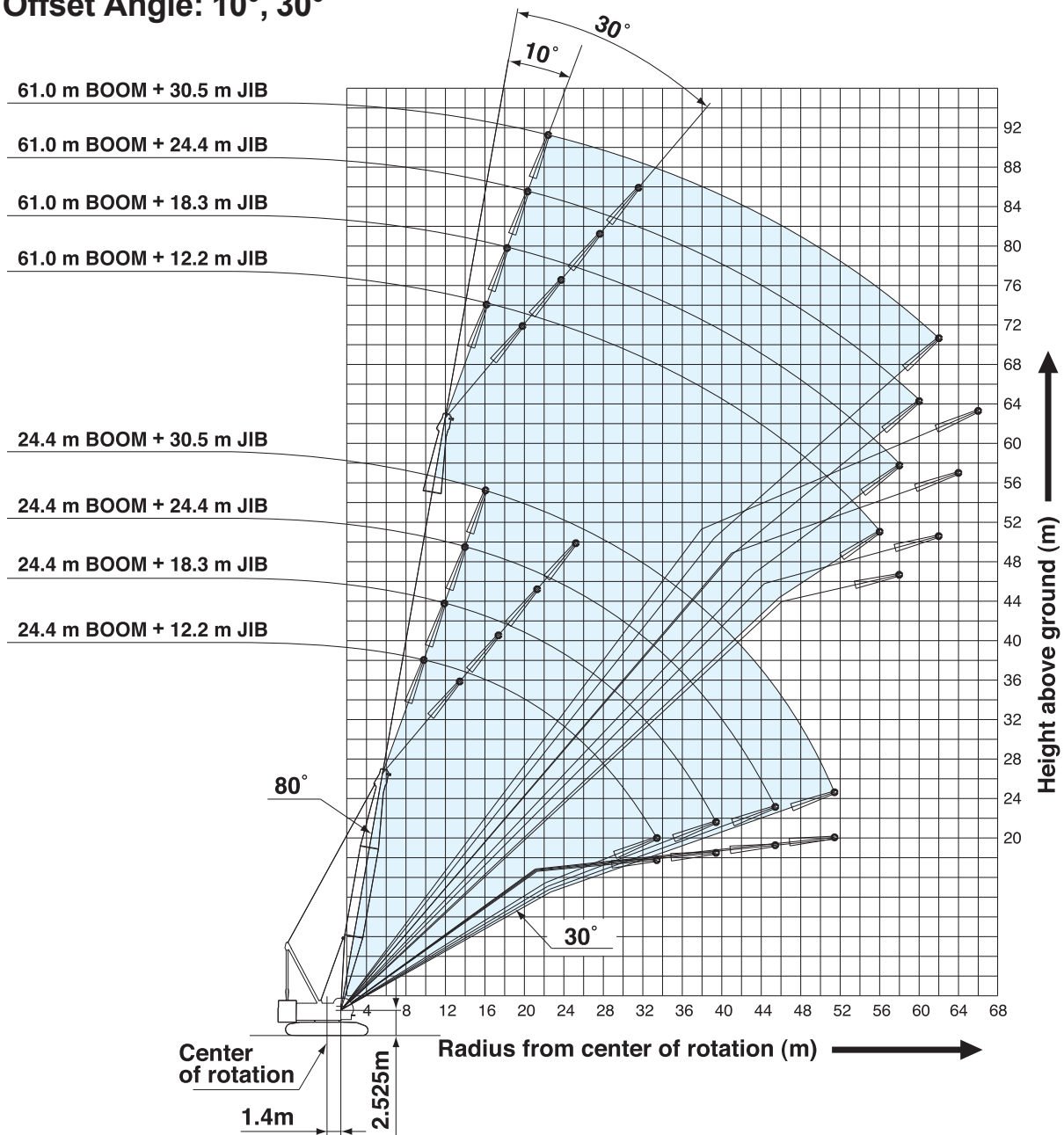

NOTES:

1. Ratings according to Japanese Construction Codes for Mobile Cranes and Japanese Safety Ordinance on Cranes, etc.
2. Ratings in metric tons for 360° working area.
3. Operating radius is the horizontal distance from center of rotation to a vertical line through the center of gravity of the load.
4. Deduct weight of main hook block, slings and all other load handling accessories from jib ratings shown.
5. Ratings shown are based on freely suspended loads and make no allowance for such factors as wind effect on lifted load, ground conditions out-of-level, operating speeds or any other condition that could be detrimental to the safe operation of this equipment. Operator, therefore, has the responsibility to judge the existing conditions and reduce lifted loads and operating speeds accordingly.
6. Ratings are for operation on a firm and level surface, up to 1% gradient.
7. At radii and boom lengths where no ratings are shown on chart, operation is not intended nor approved.
8. Boom/ jib inserts and guy lines must be arranged as shown in the "Operator's Manual".
9. Boom hoist reeving is 12 part line.
10. Gantry must be in raised position for all conditions.
11. Boom backstops are required for all boom lengths.
12. Ratings shown in are determined by the strength of the boom or other structural component.
13. Instruction in the "Operator's Manual" must be strictly observed when operating the machine.
14. Fixed jib ratings: Deduct weight of jib hook block, slings, and all other load handling accessories from jib ratings shown.
15. Boom lengths for jib mounting are 24.4 m to 61.0 m.

Fixed Jib Lifting Capacity (Without Main Hook)

Unit: metric ton

Jib Offset Angle: 10°

Counterweight: 52.3 t

Boom length (m)		24.4				30.5				36.6				42.7				Boom length (m)
Jib length (m)		12.2 m	18.3 m	24.4 m	30.5 m	12.2 m	18.3 m	24.4 m	30.5 m	12.2 m	18.3 m	24.4 m	30.5 m	12.2 m	18.3 m	24.4 m	30.5 m	Jib length (m)
Working radius (m)	10.0 m	10.2 m/12.0				11.2 m/12.0												10.0 m
	12.0 m	12.0	12.2 m/12.0			12.0	13.3 m/12.0			12.3 m/12.0				13.3 m/12.0				12.0 m
	14.0 m	12.0	12.0	14.3 m/8.0		12.0	12.0	15.4 m/8.0		12.0	14.4 m/12.0			12.0	15.4 m/12.0			14.0 m
	16.0 m	12.0	12.0	8.0	16.4 m/4.0	12.0	12.0	8.0	17.5 m/4.0	12.0	12.0	16.4 m/8.0		12.0	12.0	17.5 m/8.0		16.0 m
	18.0 m	12.0	12.0	8.0	4.0	12.0	12.0	8.0	4.0	12.0	12.0	8.0	18.5 m/4.0	12.0	12.0	8.0	19.6 m/4.0	18.0 m
	20.0 m	12.0	12.0	8.0	4.0	12.0	12.0	8.0	4.0	12.0	12.0	8.0	4.0	12.0	12.0	8.0	4.0	20.0 m
	22.0 m	12.0	12.0	7.6	4.0	12.0	12.0	8.0	4.0	12.0	12.0	8.0	4.0	12.0	12.0	8.0	4.0	22.0 m
	24.0 m	12.0	12.0	7.3	4.0	12.0	12.0	7.6	4.0	12.0	12.0	7.9	4.0	12.0	12.0	8.0	4.0	24.0 m
	26.0 m	12.0	12.0	7.0	4.0	12.0	12.0	7.3	4.0	12.0	12.0	7.6	4.0	12.0	12.0	7.9	4.0	26.0 m
	28.0 m	12.0	11.8	6.7	3.9	12.0	12.0	7.0	4.0	12.0	12.0	7.3	4.0	12.0	12.0	7.6	4.0	28.0 m
	30.0 m	12.0	11.0	6.4	3.7	11.7	11.9	6.8	3.9	11.3	11.5	7.1	4.0	11.0	11.2	7.4	4.0	30.0 m
	34.0 m	10.2	9.7	6.0	3.4	9.8	10.0	6.3	3.6	9.4	9.6	6.6	3.8	9.0	9.3	6.9	4.0	34.0 m
	38.0 m		8.7	5.6	3.1	8.3	8.5	5.9	3.3	7.9	8.1	6.2	3.5	7.6	7.8	6.5	3.7	38.0 m
	42.0 m		40.0 m/8.3	5.3	2.9	40.0 m/7.7	7.3	5.6	3.1	6.8	6.9	5.9	3.3	6.4	6.6	6.2	3.4	42.0 m
	46.0 m			44.0 m/5.2	2.7		44.0 m/6.9	5.4	2.9	44.0 m/6.3	6.0	5.6	3.1	5.5	5.7	5.9	3.2	46.0 m
	50.0 m				2.6			5.2	2.7		5.2	5.4	2.9	4.7	4.9	5.1	3.0	50.0 m
	54.0 m							2.6				4.7	2.7		4.2	4.4	2.9	54.0 m
	58.0 m							56.0 m/2.5				56.0 m/4.5	2.6		56.0 m/3.9	3.9	2.7	58.0 m
	62.0 m												60.0 m/2.5			60.0 m/3.6	2.6	62.0 m
	66.0 m																2.5	66.0 m
Reeves	1	1	1	1	1	1	1	1	1	1	1	1	1	1	1	1	Reeves	

Boom length (m)		48.8				54.9				61.0				Boom length (m)
Jib length (m)		12.2 m	18.3 m	24.4 m	30.5 m	12.2 m	18.3 m	24.4 m	30.5 m	12.2 m	18.3 m	24.4 m	30.5 m	Jib length (m)
Working radius (m)	14.0 m	14.4 m/12.0				15.4 m/12.0								14.0 m
	16.0 m	12.0	16.5 m/12.0			12.0	17.5 m/12.0			16.5 m/12.0				16.0 m
	18.0 m	12.0	12.0	18.6 m/8.0		12.0	12.0	19.6 m/8.0		12.0	18.6 m/12.0			18.0 m
	20.0 m	12.0	12.0	8.0	20.6 m/4.0	12.0	12.0	8.0	21.7 m/4.0	12.0	12.0	20.7 m/8.0		20.0 m
	22.0 m	12.0	12.0	8.0	4.0	12.0	12.0	8.0	4.0	12.0	12.0	8.0	22.8 m/4.0	22.0 m
	24.0 m	12.0	12.0	8.0	4.0	12.0	12.0	8.0	4.0	12.0	12.0	8.0	4.0	24.0 m
	26.0 m	12.0	12.0	8.0	4.0	12.0	12.0	8.0	4.0	12.0	12.0	8.0	4.0	26.0 m
	28.0 m	11.8	12.0	7.9	4.0	11.4	11.7	8.0	4.0	11.1	11.4	8.0	4.0	28.0 m
	30.0 m	10.6	10.9	7.6	4.0	10.2	10.5	7.9	4.0	9.9	10.2	8.0	4.0	30.0 m
	34.0 m	8.7	8.9	7.2	4.0	8.3	8.6	7.4	4.0	8.0	8.2	7.6	4.0	34.0 m
	38.0 m	7.2	7.4	6.8	3.8	6.8	7.1	7.0	4.0	6.5	6.7	7.1	4.0	38.0 m
	42.0 m	6.0	6.2	6.4	3.6	5.6	5.9	6.2	3.7	5.3	5.5	5.9	3.9	42.0 m
	46.0 m	5.1	5.3	5.6	3.4	4.7	4.9	5.2	3.5	4.3	4.5	4.9	3.7	46.0 m
	50.0 m	4.3	4.5	4.8	3.2	3.8	4.1	4.4	3.3	3.3	3.6	4.1	3.5	50.0 m
	54.0 m	3.6	3.8	4.1	3.0	3.0	3.3	3.7	3.2	2.5	2.8	3.2	3.3	54.0 m
	58.0 m		3.2	3.5	2.9	2.4	2.6	3.0	3.0	56.0 m/2.2	2.1	2.5	2.7	58.0 m
	62.0 m		60.0 m/2.9	2.9	2.7		2.1	2.4	2.5			60.0 m/2.2	2.1	62.0 m
	66.0 m			2.4	2.5			64.0 m/2.1	2.0					66.0 m
	70.0 m				2.1									70.0 m
	Reeves	1	1	1	1	1	1	1	1	1	1	1	1	Reeves

Note:

Ratings according to Japanese Construction Codes for Mobile Cranes and Japanese Safety Ordinance on Cranes, etc.

Ratings shown in are determined by the strength of the boom or other structural components.

Refer to notes P16.

Fixed Jib Lifting Capacities (Without Main Hook)

Unit: metric ton

Jib Offset Angle: 30°

Counterweight: 52.3 t

Boom length (m)		24.4				30.5				36.6				42.7				Boom length (m)
Jib length (m)		12.2 m	18.3 m	24.4 m	30.5 m	12.2 m	18.3 m	24.4 m	30.5 m	12.2 m	18.3 m	24.4 m	30.5 m	12.2 m	18.3 m	24.4 m	30.5 m	Jib length (m)
Working radius (m)	12.0 m	13.8 m/10.0																12.0 m
	14.0 m	10.0				14.9 m/10.0				15.9 m/10.0								14.0 m
	16.0 m	10.0	17.7 m/9.0			10.0				10.0				17.0 m/10.0				16.0 m
	18.0 m	10.0	9.0			10.0	18.8 m/9.0			10.0	19.9 m/9.0			10.0				18.0 m
	20.0 m	10.0	9.0	21.7 m/6.0		10.0	9.0			10.0	9.0			10.0	20.9 m/9.0			20.0 m
	22.0 m	10.0	9.0	6.0		10.0	9.0	22.7 m/6.0		10.0	9.0	23.8 m/6.0		10.0	9.0			22.0 m
	24.0 m	10.0	9.0	6.0	25.6 m/3.0	10.0	9.0	6.0		10.0	9.0	6.0		10.0	9.0	24.8 m/6.0		24.0 m
	26.0 m	10.0	9.0	6.0	3.0	10.0	9.0	6.0	26.6 m/3.0	10.0	9.0	6.0	27.7 m/3.0	10.0	9.0	6.0		26.0 m
	28.0 m	10.0	8.7	5.8	3.0	10.0	9.0	6.0	3.0	10.0	9.0	6.0	3.0	10.0	9.0	6.0	28.8 m/3.0	28.0 m
	30.0 m	10.0	8.3	5.7	3.0	10.0	8.9	5.8	3.0	10.0	9.0	6.0	3.0	10.0	9.0	6.0	3.0	30.0 m
	34.0 m	10.0	7.6	5.4	2.9	9.9	8.1	5.6	3.0	9.6	8.6	5.7	3.0	9.3	9.0	5.8	3.0	34.0 m
	38.0 m		7.1	5.2	2.7	8.4	7.5	5.4	2.8	8.1	8.0	5.5	2.9	7.8	8.3	5.6	3.0	38.0 m
	42.0 m		40.0 m/6.9	5.0	2.6	40.0 m/7.8	7.1	5.2	2.7	6.9	7.3	5.3	2.8	6.6	7.0	5.4	2.8	42.0 m
	46.0 m			4.7	2.5		6.5	5.0	2.6	44.0 m/6.3	6.2	5.2	2.7	5.6	6.0	5.3	2.7	46.0 m
	50.0 m				2.4			4.8	2.5		5.4	5.0	2.6	4.8	5.1	5.1	2.6	50.0 m
	54.0 m				52.0 m/2.4			52.0 m/4.7	2.4		52.0 m/5.0	4.8	2.5		4.4	4.6	2.5	54.0 m
	58.0 m								2.4			56.0 m/4.6	2.4		56.0 m/4.1	4.0	2.5	58.0 m
	62.0 m												2.4				2.4	62.0 m
	66.0 m																2.4	66.0 m
	Reeves	1	1	1	1	1	1	1	1	1	1	1	1	1	1	1	1	Reeves

Boom length (m)		48.8				54.9				61.0				Boom length (m)
Jib length (m)		12.2 m	18.3 m	24.4 m	30.5 m	12.2 m	18.3 m	24.4 m	30.5 m	12.2 m	18.3 m	24.4 m	30.5 m	Jib length (m)
Working radius (m)	18.0 m	18.1 m/10.0				19.1 m/10.0								18.0 m
	20.0 m	10.0				10.0				20.1 m/10.0				20.0 m
	22.0 m	10.0	9.0			10.0	23.0 m/9.0			10.0				22.0 m
	24.0 m	10.0	9.0	25.9 m/6.0		10.0	9.0			10.0	24.1 m/9.0			24.0 m
	26.0 m	10.0	9.0	6.0		10.0	9.0	26.9 m/6.0		10.0	9.0			26.0 m
	28.0 m	10.0	9.0	6.0	29.8 m/3.0	10.0	9.0	6.0		10.0	9.0	6.0		28.0 m
	30.0 m	10.0	9.0	6.0	3.0	10.0	9.0	6.0	30.9 m/3.0	10.0	9.0	6.0	31.9 m/3.0	30.0 m
	34.0 m	9.0	9.0	5.9	3.0	8.7	9.0	6.0	3.0	8.4	9.0	6.0	3.0	34.0 m
	38.0 m	7.5	8.0	5.7	3.0	7.1	7.7	5.8	3.0	6.8	7.4	5.9	3.0	38.0 m
	42.0 m	6.2	6.7	5.5	2.9	5.9	6.4	5.6	3.0	5.6	6.1	5.7	3.0	42.0 m
	46.0 m	5.2	5.7	5.4	2.8	4.9	5.4	5.5	2.8	4.6	5.1	5.5	2.9	46.0 m
	50.0 m	4.4	4.8	5.1	2.7	4.1	4.5	4.8	2.7	3.6	4.2	4.6	2.8	50.0 m
	54.0 m	3.7	4.1	4.4	2.6	3.2	3.8	4.1	2.6	2.8	3.4	3.8	2.7	54.0 m
	58.0 m	56.0 m/3.4	3.5	3.7	2.5	2.5	3.0	3.4	2.6	2.0	2.6	3.0	2.6	58.0 m
	62.0 m		2.8	3.2	2.5	60.0 m/2.2	2.4	2.7	2.5		2.0	2.3	2.5	62.0 m
	66.0 m			2.6	2.4		64.0 m/2.1	2.1	2.4			64.0 m/2.0	2.0	66.0 m
	70.0 m			68.0 m/2.3	2.3				68.0 m/2.1					70.0 m
	72.0 m				2.1									72.0 m
	Reeves	1	1	1	1	1	1	1	1	1	1	1	1	Reeves

Note:

Ratings according to Japanese Construction Codes for Mobile Cranes and Japanese Safety Ordinance on Cranes, etc.

Ratings shown in are determined by the strength of the boom or other structural components.

Refer to notes P16.

Luffing Tower Working Ranges

Tower Length: 39.5m

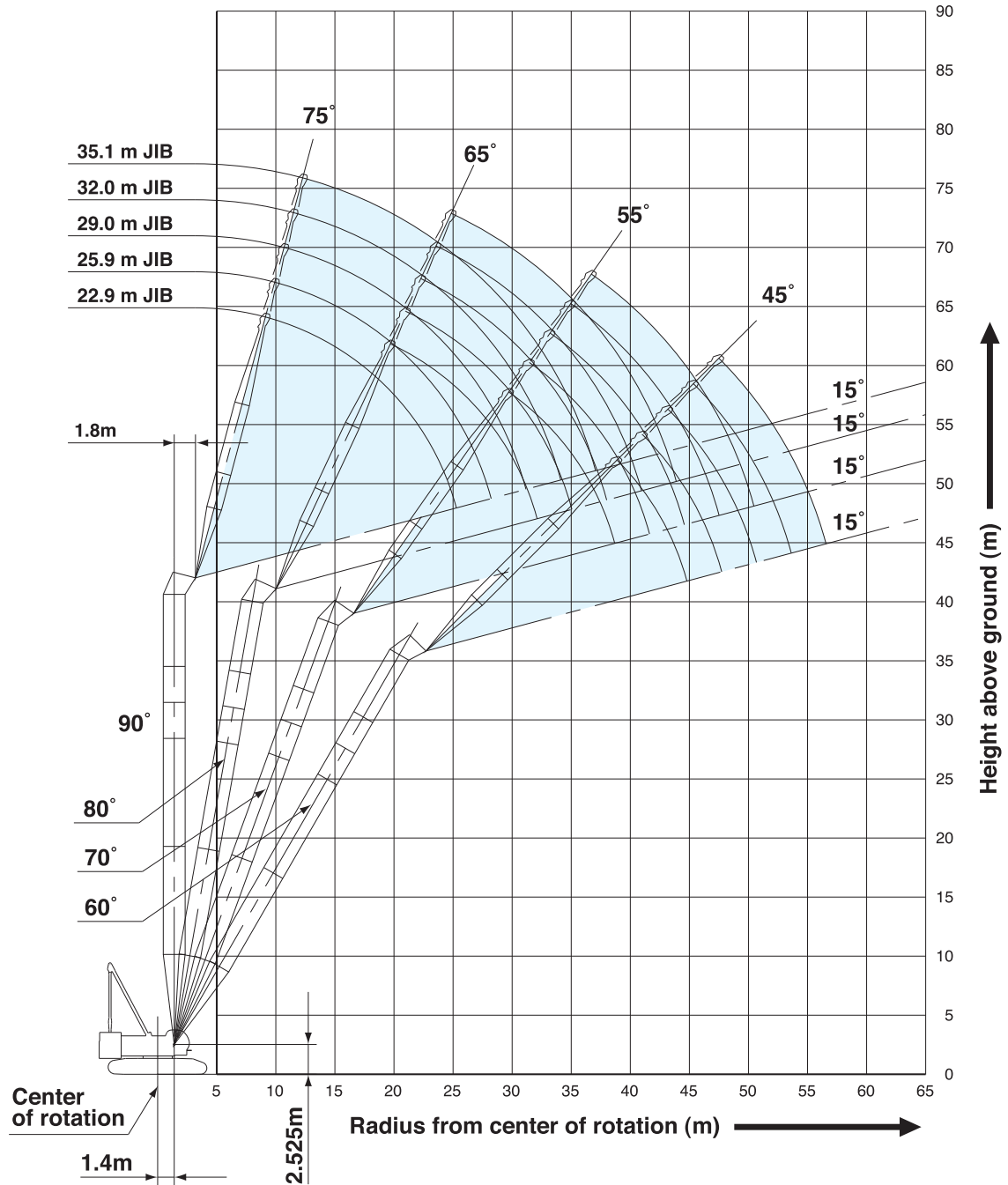

NOTES:

1. Ratings according to Japanese Construction Codes for Mobile Cranes and Japanese Safety Ordinance on Cranes, etc.
2. Ratings in metric tons for 360° working area.
3. Operating radius is the horizontal distance from center of rotation to a vertical line through the center of gravity of the load.
4. Deduct weight of hook block(s), slings and all other load handling accessories from luffing tower ratings shown.
5. Ratings shown are based on freely suspended loads and make no allowance for such factors as wind effect on lifted load, ground conditions out-of-level, operating speeds or any other condition that could be detrimental to the safe operation of this equipment. Operator, therefore,
6. has the responsibility to judge the existing conditions and reduce lifted loads and operating speeds accordingly.
7. Ratings are for operation on a firm and level surface, up to 1% gradient.
8. At radii and boom lengths where no ratings are shown on chart, operation is not intended nor approved.
9. Boom/jib inserts and guy lines must be arranged as shown in the "Operator's Manual".
10. Luffing tower hoist reeving is 12 part line.
11. Tower Jib hoist reeving is 8 part line.

Luffing Tower Working Ranges

Tower Length: 51.7m

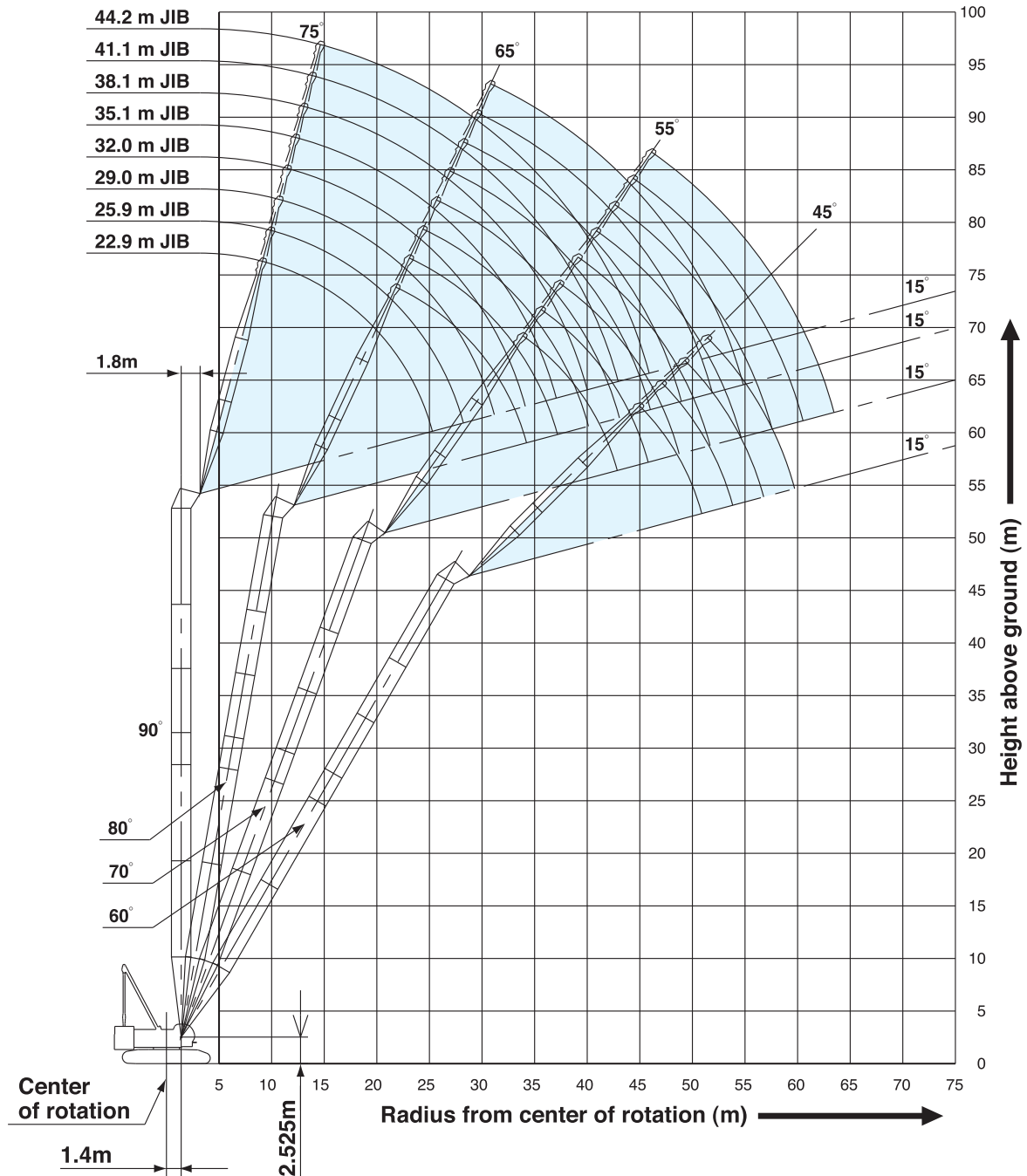

11. Gantry must be in raised position for all conditions.
12. Boom and jib backstops are required for all boom and jib combinations.
13. Ratings shown in are determined by the strength of the boom or other structural component.
14. When erecting and lowering the tower length of 51.7 m (170 ft) or over, the pillow plate for erection must be placed at the end of crawlers.
15. Instruction in the "Operator's Manual" must be strictly observed when operating the machine.

16. Luffing jib ratings: Deduct weight of hook block(s), slings, and all other load handling accessories from luffing jib ratings shown.

Luffing Tower Lifting Capacities

Unit: metric ton

Counterweight: 52.3 t

30.4 m Tower Length	Tower Length	30.4 m								Tower Length	
	Jib length	22.9 m				25.9 m				Jib length	
	Tower angle	90°	80°	70°	60°	90°	80°	70°	60°	Tower angle	
Working radius (m)	9.4 m	20.0									9.4 m
	10.0 m	20.0				10.2 m/20.0					10.0 m
	12.0 m	20.0				20.0					12.0 m
	14.0 m	20.0				20.0					14.0 m
	15.0 m	20.0				20.0					15.0 m
	16.0 m	18.7				18.7					16.0 m
	18.0 m	16.6	18.4 m/16.3			16.6	19.7 m/15.2				18.0 m
	20.0 m	15.0	15.0			15.0	15.0				20.0 m
	22.0 m	13.3	13.6			13.6	13.6				22.0 m
	24.0 m	9.9	12.5			12.1	12.5				24.0 m
	26.0 m	25.4 m/7.1	11.5	26.8 m/11.1		9.5	11.5				26.0 m
	28.0 m		10.7	10.7		6.7	10.7	28.6 m/10.4			28.0 m
	30.0 m		10.0	10.0		28.3 m/6.1	10.0	10.0			30.0 m
	32.0 m		30.6 m/9.4	9.3			9.3	9.3			32.0 m
	34.0 m			8.8	34.5 m/8.5		33.5 m/7.7	8.8			34.0 m
	36.0 m			35.6 m/8.4	7.9			8.3	36.7 m/7.7		36.0 m
	38.0 m				7.5			7.8	7.3		38.0 m
	40.0 m				7.0			38.6 m/7.7	6.9		40.0 m
42.0 m				40.3 m/6.9				6.4		42.0 m	
44.0 m								43.2 m/6.2		44.0 m	
Reeves	2	2	2	2	2	2	2	2	2	Reeves	

33.4 m Tower Length	Tower Length	33.4 m								29.0 m				Tower Length
	Jib length	22.9 m				25.9 m				29.0 m				Jib length
	Tower angle	90°	80°	70°	60°	90°	80°	70°	60°	90°	80°	70°	60°	Tower angle
Working radius (m)	9.4 m	20.0												9.4 m
	10.0 m	20.0				10.2 m/20.0				11.0 m/20.0				10.0 m
	12.0 m	20.0				20.0				20.0				12.0 m
	14.0 m	20.0				20.0				20.0				14.0 m
	15.0 m	20.0				20.0				20.0				15.0 m
	16.0 m	18.7				18.7				18.7				16.0 m
	18.0 m	16.6	18.9 m/15.8			16.6				16.6				18.0 m
	20.0 m	15.0	15.0			15.0	20.2 m/14.8			15.0	21.5 m/13.9			20.0 m
	22.0 m	13.4	13.6			13.6	13.6			13.6	13.6			22.0 m
	24.0 m	10.0	12.5			12.3	12.5			12.5	12.5			24.0 m
	26.0 m	25.4 m/7.2	11.5	27.9 m/10.7		9.7	11.5			11.2	11.5			26.0 m
	28.0 m		10.7	10.7		6.9	10.7	29.6 m/10.1		9.1	10.7			28.0 m
	30.0 m		10.0	10.0		28.3 m/6.2	10.0	10.0		7.0	10.0	31.4 m/9.5		30.0 m
	32.0 m		31.1 m/9.5	9.3			9.3	9.3		31.2 m/5.3	9.3	9.3		32.0 m
	34.0 m			8.8			8.6	8.8			8.8	8.8		34.0 m
	36.0 m			8.3	7.6		34.1 m/8.1	8.3			8.3	8.3		36.0 m
	38.0 m			36.7 m/8.1	7.0			7.8	38.2 m/6.9		37.0 m/7.0	7.8		38.0 m
	40.0 m				6.6			39.6 m/7.5	6.4			7.4	40.3 m/6.3	40.0 m
42.0 m				41.8 m/6.2				6.1			6.9	5.8	42.0 m	
44.0 m								5.7			42.6 m/6.8	5.6	44.0 m	
46.0 m								44.8 m/5.6				5.2	46.0 m	
48.0 m												47.7 m/5.0	48.0 m	
Reeves	2	2	2	2	2	2	2	2	2	2	2	2	Reeves	

Note:

Ratings according to Japanese Construction Codes for Mobile Cranes and Japanese Safety Ordinance on Cranes, etc.

Ratings shown in are determined by the strength of the boom or other structural components.

Refer to notes P19 and P20.

Unit: metric ton

Counterweight: 52.3 t

36.5 m Tower Length	36.5 m																	Tower Length
	Jib length	22.9 m				25.9 m				29.0 m				32.0 m				Jib length
	Tower angle	90°	80°	70°	60°	90°	80°	70°	60°	90°	80°	70°	60°	90°	80°	70°	60°	Tower angle
Working radius (m)	9.4 m	20.0																9.4 m
	10.0 m	20.0				10.2 m/20.0				11.0 m/20.0				11.8 m/20.0				10.0 m
	12.0 m	20.0				20.0				20.0				20.0				12.0 m
	14.0 m	20.0				20.0				20.0				19.6				14.0 m
	15.0 m	20.0				20.0				20.0				19.1				15.0 m
	16.0 m	18.7				18.7				18.7				18.6				16.0 m
	18.0 m	16.6	19.4 m/15.4			16.6				16.6				16.6				18.0 m
	20.0 m	15.0	15.0			15.0	20.7 m/14.4			15.0				15.0				20.0 m
	22.0 m	13.5	13.6			13.6	13.6			13.6	13.6			13.6	23.3 m/12.8			22.0 m
	24.0 m	10.1	12.5			12.4	12.5			12.5	12.5			12.5	12.5			24.0 m
	26.0 m	25.4 m/7.3	11.5			9.8	11.5			11.2	11.5			11.5	11.5			26.0 m
	28.0 m		10.7	28.9 m/10.3		6.9	10.7			9.2	10.7			10.2	10.7			28.0 m
	30.0 m		10.0	10.0		28.3 m/6.3	10.0	30.7 m/9.7		7.1	10.0			8.6	10.0			30.0 m
	32.0 m		31.7 m/9.4	9.3			9.3	9.3		31.2 m/5.4	9.3	32.4 m/9.2		6.9	9.3			32.0 m
	34.0 m			8.8			8.8	8.8			8.8	8.7		5.0	8.8	34.2 m/8.6		34.0 m
	36.0 m			8.3	37.6 m/6.8		34.6 m/8.2	8.3			8.3	8.2		34.2 m/4.6	8.3	8.0		36.0 m
	38.0 m			37.7 m/7.9	6.6			7.8	39.7 m/6.2		37.6 m/7.1	7.7			7.8	7.6		38.0 m
	40.0 m				6.2			7.2	6.0			7.2	41.9 m/5.6		7.0	7.1		40.0 m
	42.0 m				5.8			40.7 m/7.1	5.7			6.7	5.5	40.5 m/6.2	6.6			42.0 m
	44.0 m				43.3 m/5.6				5.4			43.6 m/6.3	5.2			6.2	5.0	44.0 m
	46.0 m								5.0				4.9			5.9	4.7	46.0 m
	48.0 m								46.3 m/5.0				4.6		46.5 m/5.7	4.6		48.0 m
	50.0 m												49.2 m/4.4				4.3	50.0 m
	52.0 m																4.0	52.0 m
	54.0 m																52.2 m/3.8	54.0 m
	Reeves	2	2	2	2	2	2	2	2	2	2	2	2	2	2	2	2	Reeves

39.5 m Tower Length	39.5 m																	Tower Length					
	Jib length	22.9 m				25.9 m				29.0 m				32.0 m				35.1 m				Jib length	
	Tower angle	90°	80°	70°	60°	90°	80°	70°	60°	90°	80°	70°	60°	90°	80°	70°	60°	90°	80°	70°	60°	Tower angle	
Working radius (m)	9.4 m	20.0																				9.4 m	
	10.0 m	20.0				10.2 m/20.0				11.0 m/20.0				11.8 m/20.0								10.0 m	
	12.0 m	20.0				20.0				20.0				20.0				12.5 m/16.5				12.0 m	
	14.0 m	20.0				20.0				20.0				19.6				16.3				14.0 m	
	15.0 m	20.0				20.0				20.0				19.1				16.0				15.0 m	
	16.0 m	18.7				18.7				18.7				18.6				15.7				16.0 m	
	18.0 m	16.6				16.6				16.6				16.6				15.3				18.0 m	
	20.0 m	15.0	15.0			15.0	21.2 m/14.1			15.0				15.0				14.9				20.0 m	
	22.0 m	13.6	13.6			13.6	13.6			13.6	22.5 m/13.3			13.6	23.8 m/12.6			13.6				22.0 m	
	24.0 m	10.2	12.5			12.4	12.5			12.5	12.5			12.5	12.5			12.5	25.1 m/11.9			24.0 m	
	26.0 m	25.4 m/7.4	11.5			9.8	11.5			11.3	11.5			11.5	11.5			11.5	11.5			26.0 m	
	28.0 m		10.7			7.0	10.7			9.3	10.7			10.2	10.7			10.7	10.7			28.0 m	
	30.0 m		10.0	10.0		28.3 m/6.3	10.0	31.7 m/9.4		7.2	10.0			8.6	10.0			9.4	10.0			30.0 m	
	32.0 m		9.3	9.3			9.3	9.2		31.2 m/5.4	9.3	33.5 m/8.6		6.9	9.3			8.0	9.3			32.0 m	
	34.0 m		32.2 m/9.3	8.7			8.8	8.6			8.8	8.4		5.0	8.8	35.2 m/8.0		6.7	8.8			34.0 m	
	36.0 m			8.1			35.1 m/8.2	8.0			8.3	7.9		34.2 m/4.7	8.3	7.7		5.2	8.3	36.9 m/7.4		36.0 m	
	38.0 m			7.5	39.1 m/6.0			7.5			7.5	7.3			7.8	7.2		37.1 m/4.1	7.8	7.0		38.0 m	
	40.0 m			38.8 m/7.3	5.7			7.0	41.2 m/5.3		38.1 m/7.1	6.9			7.4	6.8			7.5	6.7		40.0 m	
	42.0 m				5.4			41.7 m/6.5	5.2			6.4	43.4 m/4.7		41.0 m/6.2	6.3			7.1	6.3		42.0 m	
	44.0 m				5.1				5.0			6.0	4.7		6.0	45.5 m/4.3			5.4	5.9		44.0 m	
	46.0 m				44.9 m/4.8				4.7			44.6 m/5.9	4.5			5.6	4.3			5.5	47.7 m/4.0	46.0 m	
	48.0 m								47.8 m/4.4				4.3		47.6 m/5.3	4.2				5.2	4.0	48.0 m	
	50.0 m												4.0			3.9				4.9	3.8	50.0 m	
	52.0 m												50.8 m/3.9			3.7				50.5 m/4.8	3.6	52.0 m	
	54.0 m																53.7 m/3.5				3.4	54.0 m	
	56.0 m																					3.2	56.0 m
	58.0 m																					56.6 m/3.1	58.0 m
	Reeves	2	2	2	2	2	2	2	2	2	2	2	2	2	2	2	2	2	2	2	2	2	Reeves

Note:

Ratings according to Japanese Construction Codes for Mobile Cranes and Japanese Safety Ordinance on Cranes, etc.

Ratings shown in [] are determined by the strength of the boom or other structural components.

Refer to notes P19 and P20.

Unit: metric ton

Counterweight: 52.3 t

42.5 m Tower Length	Tower Length	42.5 m												Tower Length
	Jib length	22.9 m				25.9 m				29.0 m				Jib length
	Tower angle	90°	80°	70°	60°	90°	80°	70°	60°	90°	80°	70°	60°	Tower angle
Working radius (m)	9.4 m	20.0												9.4 m
	10.0 m	20.0				10.2 m/20.0				11.0 m/20.0				10.0 m
	12.0 m	20.0				20.0				20.0				12.0 m
	14.0 m	20.0				20.0				20.0				14.0 m
	15.0 m	20.0				20.0				20.0				15.0 m
	16.0 m	18.7				18.7				18.7				16.0 m
	18.0 m	16.6				16.6				16.6				18.0 m
	20.0 m	15.0	20.5 m/14.6			15.0	21.8 m/13.7			15.0				20.0 m
	22.0 m	13.6	13.6			13.6	13.6			13.6	23.1 m/12.9			22.0 m
	24.0 m	10.3	12.5			12.5	12.5			12.5	12.5			24.0 m
	26.0 m	25.4 m/7.5	11.5			9.9	11.5			11.3	11.5			26.0 m
	28.0 m		10.7			7.1	10.7			9.3	10.7			28.0 m
	30.0 m		10.0	31.0 m/9.5		28.3 m/6.4	10.0			7.2	10.0			30.0 m
	32.0 m		9.3	9.0			9.3	32.7 m/8.7		31.2 m/5.5	9.3			32.0 m
	34.0 m		32.7 m/9.1	8.4			8.8	8.2		8.8	34.5 m/8.0			34.0 m
	36.0 m			7.8			35.7 m/8.2	7.7		8.3	7.5			36.0 m
	38.0 m			7.3				7.2		7.8	7.1			38.0 m
	40.0 m			39.8 m/6.8	40.6 m/5.2			6.7		38.6 m/7.1	6.6			40.0 m
	42.0 m				5.0			6.3	42.8 m/4.6		6.2			42.0 m
	44.0 m				4.7			42.7 m/6.1	4.5		5.8	44.9 m/4.2		44.0 m
46.0 m				4.4				4.3		45.7 m/5.4	4.1		46.0 m	
48.0 m				46.4 m/4.3				4.1			3.9		48.0 m	
50.0 m								49.3 m/3.9			3.7		50.0 m	
52.0 m											3.5		52.0 m	
54.0 m											52.3 m/3.4		54.0 m	
Reeves	2	2	2	2	2	2	2	2	2	2	2	2	Reeves	

42.5 m Tower Length	Tower Length	42.5 m												Tower Length
	Jib length	32.0 m				35.1 m				38.1 m				Jib length
	Tower angle	90°	80°	70°	60°	90°	80°	70°	60°	90°	80°	70°	60°	Tower angle
Working radius (m)	10.0 m	11.8 m/20.0												10.0 m
	12.0 m	20.0				12.5 m/16.5				13.3 m/13.6				12.0 m
	14.0 m	19.5				16.2				13.6				14.0 m
	15.0 m	19.0				16.0				13.4				15.0 m
	16.0 m	18.5				15.7				13.1				16.0 m
	18.0 m	16.6				15.3				12.7				18.0 m
	20.0 m	15.0				14.8				12.3				20.0 m
	22.0 m	13.6				13.6				11.9				22.0 m
	24.0 m	12.5	24.4 m/12.2			12.5	25.6 m/11.7			11.6				24.0 m
	26.0 m	11.5	11.5			11.5	11.5			11.2	26.9 m/11.1			26.0 m
	28.0 m	10.3	10.7			10.7	10.7			10.5	10.7			28.0 m
	30.0 m	8.7	10.0			9.4	10.0			9.6	10.0			30.0 m
	32.0 m	7.0	9.3			8.0	9.3			8.5	9.3			32.0 m
	34.0 m	5.1	8.8			6.7	8.8			7.4	8.8			34.0 m
	36.0 m	34.2 m/4.7	8.3	36.2 m/7.4		5.3	8.3			6.3	8.3			36.0 m
	38.0 m		7.8	6.8		37.1 m/4.1	7.8	6.8		5.1	7.8	39.7 m/6.3		38.0 m
	40.0 m		7.5	6.5			7.5	6.4		3.7	7.5	6.1		40.0 m
	42.0 m		41.5 m/6.2	6.1			7.1	6.0		40.1 m/3.5	7.1	5.9		42.0 m
	44.0 m			5.7			6.1	5.6			6.7	5.5		44.0 m
	46.0 m			5.4	47.1 m/3.8		44.5 m/5.4	5.3			5.9	5.2		46.0 m
48.0 m			5.0	3.7			5.0	49.2 m/3.4		47.4 m/4.7	4.9		48.0 m	
50.0 m			48.6 m/4.9	3.6			4.7	3.4		4.6	51.4 m/3.2		50.0 m	
52.0 m				3.4			51.6 m/4.4	3.3		4.3	3.1		52.0 m	
54.0 m				3.2				3.1		4.1	3.0		54.0 m	
56.0 m				55.2 m/3.0				2.9		54.5 m/3.8	2.8		56.0 m	
58.0 m								2.8			2.6		58.0 m	
60.0 m								58.2 m/2.7			2.5		60.0 m	
62.0 m											61.1 m/2.4		62.0 m	
Reeves	2	2	2	2	2	2	2	2	2	2	2	2	Reeves	

Note:

Ratings according to Japanese Construction Codes for Mobile Cranes and Japanese Safety Ordinance on Cranes, etc.

Ratings shown in are determined by the strength of the boom or other structural components.

Refer to notes P19 and P20.

Unit: metric ton

Counterweight: 52.3 t

45.6 m Tower Length	45.6 m																	
	Tower Length	45.6 m															Tower Length	
	Jib length	22.9 m				25.9 m				29.0 m				32.0 m			Jib length	
Tower angle	90°	80°	70°	60°	90°	80°	70°	60°	90°	80°	70°	60°	90°	80°	70°	60°	Tower angle	
9.4 m	20.0																9.4 m	
10.0 m	20.0				10.2 m/20.0				11.0 m/20.0				11.8 m/20.0				10.0 m	
12.0 m	20.0				20.0				20.0				20.0				12.0 m	
14.0 m	20.0				20.0				20.0				19.5				14.0 m	
15.0 m	20.0				20.0				20.0				19.0				15.0 m	
16.0 m	18.7				18.7				18.7				18.5				16.0 m	
18.0 m	16.6				16.6				16.6				16.6				18.0 m	
20.0 m	15.0	21.0 m/14.2			15.0				15.0				15.0				20.0 m	
22.0 m	13.6	13.6			13.6	22.3 m/13.4			13.6	23.6 m/12.7			13.6				22.0 m	
24.0 m	10.3	12.5			12.5	12.5			12.5	12.5			12.5	24.9 m/12.0			24.0 m	
26.0 m	25.4 m/7.5	11.5			9.9	11.5			11.3	11.5			11.5	11.5			26.0 m	
28.0 m		10.7			7.1	10.7			9.3	10.7			10.3	10.7			28.0 m	
30.0 m		10.0			28.3 m/6.4	10.0			7.2	10.0			8.7	10.0			30.0 m	
32.0 m		9.3	8.7			9.3	33.8 m/8.0		31.2 m/5.5	9.3			7.0	9.3			32.0 m	
34.0 m		33.2 m/9.0	8.0			8.8	7.8		8.8	35.5 m/7.4			5.2	8.8			34.0 m	
36.0 m			7.5			8.3	7.4		8.3	7.1			34.2 m/4.8	8.3	37.3 m/6.8		36.0 m	
38.0 m			7.0			36.2 m/8.2	6.9			7.8	6.8			7.8	6.5		38.0 m	
40.0 m			6.5				6.4			39.1 m/7.1	6.3			7.5	6.2		40.0 m	
42.0 m			40.8 m/6.3	42.1 m/4.4			6.0						5.9		6.5	5.8	42.0 m	
44.0 m				4.3			43.8 m/5.6	44.3 m/4.0					5.5		42.1 m/6.2	5.5	44.0 m	
46.0 m				4.1				3.9					5.2	46.4 m/3.6		5.1	46.0 m	
48.0 m				47.9 m/3.9				3.7					46.7 m/5.0	3.5		4.8	48.6 m/3.3	48.0 m
50.0 m								3.5					3.4		49.7 m/4.4	3.2		50.0 m
52.0 m								50.9 m/3.4					3.2				3.1	52.0 m
54.0 m													53.8 m/3.0				2.9	54.0 m
56.0 m																	2.7	56.0 m
58.0 m																	56.7 m/2.6	58.0 m
Reeves	2	2	2	2	2	2	2	2	2	2	2	2	2	2	2	2	2	Reeves

45.6 m Tower Length	45.6 m												
	Tower Length	45.6 m											Tower Length
	Jib length	35.1 m				38.1 m				41.1 m			Jib length
Tower angle	90°	80°	70°	60°	90°	80°	70°	60°	90°	80°	70°	Tower angle	
12.0 m	12.5 m/16.5				13.3 m/13.6							12.0 m	
14.0 m	16.2				13.6				14.1 m/10.7			14.0 m	
15.0 m	16.0				13.3				10.7			15.0 m	
16.0 m	15.7				13.1				10.5			16.0 m	
18.0 m	15.2				12.7				10.2			18.0 m	
20.0 m	14.8				12.3				9.8			20.0 m	
22.0 m	13.6				11.9				9.5			22.0 m	
24.0 m	12.5				11.6				9.2			24.0 m	
26.0 m	11.5	26.2 m/11.4			11.1	27.5 m/10.9			8.9			26.0 m	
28.0 m	10.7	10.7			10.5	10.7			8.6	28.7 m/9.8		28.0 m	
30.0 m	9.4	10.0			9.6	10.0			8.3	9.6		30.0 m	
32.0 m	8.1	9.3			8.5	9.3			7.8	9.3		32.0 m	
34.0 m	6.7	8.8			7.4	8.8			7.3	8.8		34.0 m	
36.0 m	5.3	8.3			6.3	8.3			6.8	8.3		36.0 m	
38.0 m	37.1 m/4.1	7.8	39.0 m/6.3		5.1	7.8			6.2	7.8		38.0 m	
40.0 m		7.5	6.0		3.8	7.5	40.8 m/5.7		5.2	7.5		40.0 m	
42.0 m		7.1	5.7		40.1 m/3.5	7.1	5.4		4.1	7.1	42.5 m/5.4	42.0 m	
44.0 m		6.8	5.4			6.7	5.2		43.0 m/3.2	6.6	5.0	44.0 m	
46.0 m		45.0 m/5.4	5.1			6.2	4.9			6.2	4.8	46.0 m	
48.0 m			4.8			4.7	4.6			5.8	4.5	48.0 m	
50.0 m			4.5	50.7 m/3.0			4.4			5.2	4.3	50.0 m	
52.0 m			4.2	2.9			4.1	52.9 m/2.7		50.9 m/4.3	4.0	52.0 m	
54.0 m			52.6 m/3.9	2.8			3.9	2.6			3.8	54.0 m	
56.0 m				2.7			55.6 m/3.4	2.5			3.5	56.0 m	
58.0 m				2.5				2.4			3.3	58.0 m	
60.0 m				59.7 m/2.3				2.2			58.5 m/3.1	60.0 m	
62.0 m								2.1				62.0 m	
64.0 m								62.6 m/2.0				64.0 m	
Reeves	2	2	2	2	2	2	2	2	2	2	2	Reeves	

Note:
 Ratings according to Japanese Construction Codes for Mobile Cranes and Japanese Safety Ordinance on Cranes, etc.
 Ratings shown in [] are determined by the strength of the boom or other structural components.
 Refer to notes P19 and P20.

Unit: metric ton

Counterweight: 52.3 t

48.6 m Tower Length	48.6 m																Working radius (m)
	Tower Length	48.6 m														Tower Length	
	Jib length	22.9 m				25.9 m				29.0 m				32.0 m			
Tower angle	90°	80°	70°	60°	90°	80°	70°	60°	90°	80°	70°	60°	90°	80°	70°	60°	Tower angle
9.4 m	20.0																9.4 m
10.0 m	20.0				10.2 m/20.0					11.0 m/20.0					11.8 m/19.9		10.0 m
12.0 m	20.0				20.0					20.0					19.9		12.0 m
14.0 m	20.0				20.0					19.5					18.6		14.0 m
15.0 m	20.0				19.8					18.9					18.0		15.0 m
16.0 m	18.7				18.7					18.3					17.5		16.0 m
18.0 m	16.6				16.6					16.6					16.5		18.0 m
20.0 m	15.0	21.5 m/13.9			15.0					15.0					15.0		20.0 m
22.0 m	13.6	13.6			13.6	22.8 m/13.1				13.6					13.6		22.0 m
24.0 m	10.4	12.5			12.5	12.5				12.5	24.1 m/12.4				12.5	25.4 m/11.8	24.0 m
26.0 m	25.4 m/7.5	11.5			10.0	11.5				11.4	11.5				11.5	11.5	26.0 m
28.0 m		10.7			7.1	10.7				9.4	10.7				10.3	10.7	28.0 m
30.0 m		10.0			28.3 m/6.4	10.0				7.3	10.0				8.7	10.0	30.0 m
32.0 m		9.3	33.1 m/8.0			9.3				31.2 m/5.5	9.3				7.1	9.3	32.0 m
34.0 m		33.8 m/8.8	7.6			8.8	34.8 m/7.4			8.8					5.2	8.8	34.0 m
36.0 m			7.2			8.3	6.9			8.3	36.6 m/6.8			34.2 m/4.8	8.3		36.0 m
38.0 m			6.7			36.7 m/8.1	6.6			7.8	6.3				7.8	38.3 m/6.2	38.0 m
40.0 m			6.3				6.2			39.7 m/7.1	6.0				7.3	5.8	40.0 m
42.0 m			41.9 m/5.8	43.7 m/3.8			5.8				5.6				6.7	5.5	42.0 m
44.0 m				3.8			5.4	45.8 m/3.4			5.3			42.6 m/6.2	5.2		44.0 m
46.0 m				3.7			44.8 m/5.2	3.4			5.0				4.9		46.0 m
48.0 m				3.4				3.3			47.8 m/4.5	3.1			4.6		48.0 m
50.0 m				49.4 m/3.1				3.1				3.0			4.3	50.1 m/2.7	50.0 m
52.0 m								2.9				2.8			50.7 m/4.0	2.6	52.0 m
54.0 m								52.4 m/2.8				2.6				2.5	54.0 m
56.0 m												55.3 m/2.4				2.4	56.0 m
58.0 m																2.2	58.0 m
60.0 m																58.3 m/2.1	60.0 m
Reeves	2	2	2	2	2	2	2	2	2	2	2	2	2	2	2	2	Reeves

48.6 m Tower Length	48.6 m														Working radius (m)		
	Tower Length	48.6 m												Tower Length			
	Jib length	35.1 m				38.1 m				41.1 m				44.2 m			
Tower angle	90°	80°	70°	60°	90°	80°	70°	90°	80°	70°	90°	80°	70°	90°	80°	70°	Tower angle
12.0 m	12.5 m/16.5				13.3 m/13.6												12.0 m
14.0 m	16.2				13.6			14.1 m/10.7			14.9 m/9.1						14.0 m
15.0 m	15.9				13.3			10.7			9.1						15.0 m
16.0 m	15.7				13.1			10.5			8.9						16.0 m
18.0 m	15.2				12.7			10.1			8.6						18.0 m
20.0 m	14.8				12.3			9.8			8.3						20.0 m
22.0 m	13.6				11.9			9.5			8.0						22.0 m
24.0 m	12.5				11.5			9.2			7.7						24.0 m
26.0 m	11.5	26.7 m/11.2			11.1			8.9			7.4						26.0 m
28.0 m	10.7	10.7			10.5	10.7		8.6	29.3 m/9.8		7.2						28.0 m
30.0 m	9.4	10.0			9.6	10.0		8.3	9.6		6.9	30.6 m/8.0					30.0 m
32.0 m	8.1	9.3			8.5	9.3		7.8	9.2		6.7	7.8					32.0 m
34.0 m	6.7	8.8			7.4	8.8		7.3	8.8		6.4	7.6					34.0 m
36.0 m	5.3	8.3			6.3	8.3		6.8	8.3		6.0	7.3					36.0 m
38.0 m	37.1 m/4.1	7.8			5.1	7.8		6.2	7.8		5.6	7.1					38.0 m
40.0 m		7.5	40.1 m/5.7		3.8	7.5	41.8 m/5.2	5.2	7.3		5.2	6.9					40.0 m
42.0 m		7.1	5.3		40.1 m/3.5	6.9	5.2	4.1	6.8	43.6 m/4.8	4.8	6.7					42.0 m
44.0 m		6.5	5.1			6.5	5.0	43.0 m/3.2	6.4	4.7	4.0	6.2	45.3 m/4.4				44.0 m
46.0 m		45.6 m/5.4	4.8			6.0	4.7		5.9	4.6	2.8	5.8	4.3				46.0 m
48.0 m			4.5			5.5	4.4		5.5	4.3		5.5	4.1				48.0 m
50.0 m			4.2			48.5 m/4.7	4.1		5.1	4.0		5.1	3.9				50.0 m
52.0 m			4.0	52.3 m/2.4			3.8		51.4 m/4.3	3.7		4.7	3.6				52.0 m
54.0 m			53.7 m/3.5	2.3			3.6			3.5		4.3	3.4				54.0 m
56.0 m				2.2			3.4			3.3		54.4 m/3.8	3.1				56.0 m
58.0 m				2.1			56.6 m/3.3			3.0			2.9				58.0 m
60.0 m				2.0						59.6 m/2.8			2.7				60.0 m
62.0 m													2.5				62.0 m
64.0 m													62.5 m/2.4				64.0 m
Reeves	2	2	2	2	2	2	2	2	2	2	2	2	2	2	2	2	Reeves

Note:
 Ratings according to Japanese Construction Codes for Mobile Cranes and Japanese Safety Ordinance on Cranes, etc.
 Ratings shown in are determined by the strength of the boom or other structural components.
 Refer to notes P19 and P20.

Unit: metric ton

Counterweight: 52.3 t

51.7 m Tower Length	51.7 m																		
	Tower Length	51.7 m												Tower Length					
	Jib length	22.9 m				25.9 m				29.0 m				32.0 m				Jib length	
	Tower angle	90°	80°	70°	60°	90°	80°	70°	60°	90°	80°	70°	60°	90°	80°	70°	60°	Tower angle	
Working radius (m)	9.4 m	20.0																9.4 m	
	10.0 m	20.0				10.2 m/20.0				11.0 m/20.0						11.8 m/18.6		10.0 m	
	12.0 m	20.0				20.0				19.4						18.6		12.0 m	
	14.0 m	20.0				19.2				18.2						17.4		14.0 m	
	15.0 m	20.0				18.6				17.7						16.8		15.0 m	
	16.0 m	18.7				18.1				17.2						16.4		16.0 m	
	18.0 m	16.6				16.6				16.3						15.5		18.0 m	
	20.0 m	15.0				15.0				15.0						14.7		20.0 m	
	22.0 m	13.6	22.1 m/13.5			13.6	23.4 m/12.8			13.6						13.6		22.0 m	
	24.0 m	10.4	12.5			12.5	12.5			12.5	24.7 m/12.1				12.5	25.9 m/11.5		24.0 m	
	26.0 m	25.4 m/7.6	11.5			10.0	11.5			11.4	11.5				11.5	11.5		26.0 m	
	28.0 m		10.7			7.2	10.7			9.4	10.7				10.3	10.7		28.0 m	
	30.0 m		10.0			28.3 m/6.5	10.0			7.3	10.0				8.7	10.0		30.0 m	
	32.0 m		9.3				9.3			31.2 m/5.5	9.3				7.1	9.3		32.0 m	
	34.0 m		8.8	34.1 m/7.3			8.8	35.9 m/6.6			8.8				5.2	8.8		34.0 m	
	36.0 m		34.3 m/8.7	6.7			8.3	6.5			8.3	37.6 m/6.0			34.2 m/4.8	8.3		36.0 m	
	38.0 m			6.3			37.3 m/8.2	6.2			7.6	5.9			7.8	39.4 m/5.4		38.0 m	
	40.0 m			5.9				5.8			6.9	5.7			7.4	5.4		40.0 m	
	42.0 m			5.5				5.4			40.2 m/6.8	5.3			6.8	5.2		42.0 m	
	44.0 m				42.9 m/5.2	45.2 m/3.3			5.1			5.0			43.1 m/6.2	4.9		44.0 m	
	46.0 m					3.2			45.9 m/4.8	47.3 m/3.0			4.7			4.6		46.0 m	
	48.0 m					3.1				2.9			4.4	49.5 m/2.6		4.3		48.0 m	
	50.0 m					2.9				2.8			48.8 m/4.2	2.6		4.0	51.6 m/2.2	50.0 m	
	52.0 m						51.0 m/2.8			2.6				2.5			51.8 m/3.7	2.2	52.0 m
	54.0 m									53.9 m/2.4				2.3				2.1	54.0 m
	56.0 m													2.1				2.0	56.0 m
	58.0 m													56.8 m/2.0					58.0 m
	Reeves	2	2	2	2	2	2	2	2	2	2	2	2	2	2	2	2	2	Reeves

51.7 m Tower Length	51.7 m												Tower Length					
	Jib length	35.1 m				38.1 m				41.1 m				44.2 m		Jib length		
	Tower angle	90°	80°	70°	90°	80°	70°	90°	80°	70°	90°	80°	70°	Tower angle				
	Working radius (m)	12.0 m	12.5 m/16.5				13.3 m/13.6											
	14.0 m	16.2				13.6				14.1 m/10.7				14.9 m/9.1				14.0 m
	15.0 m	15.9				13.3				10.7				9.1				15.0 m
	16.0 m	15.6				13.1				10.5				8.9				16.0 m
	18.0 m	14.7				12.6				10.1				8.6				18.0 m
	20.0 m	14.0				12.2				9.8				8.3				20.0 m
	22.0 m	13.4				11.9				9.5				8.0				22.0 m
	24.0 m	12.5				11.5				9.1				7.7				24.0 m
	26.0 m	11.5	27.2 m/10.7			11.1				8.9				7.4				26.0 m
	28.0 m	10.7	10.3			10.4	28.5 m/10.0			8.6	29.8 m/8.5			7.1				28.0 m
	30.0 m	9.4	9.9			9.6	9.1			8.3	8.5			6.9	31.1 m/8.0			30.0 m
	32.0 m	8.1	9.3			8.5	8.8			7.8	8.2			6.7	7.6			32.0 m
	34.0 m	6.8	8.8			7.4	8.5			7.3	7.9			6.4	7.3			34.0 m
	36.0 m	5.3	8.3			6.3	8.2			6.8	7.6			6.0	7.1			36.0 m
	38.0 m	37.1 m/4.2	7.8			5.2	7.7			6.3	7.4			5.6	6.8			38.0 m
	40.0 m		7.3	41.1 m/4.9		3.8	7.1			5.2	7.0			5.2	6.6			40.0 m
	42.0 m		6.8	4.9	40.1 m/3.5		6.6	42.9 m/4.4		4.1	6.5			4.8	6.4			42.0 m
	44.0 m		6.3	4.8			6.2	4.4	43.0 m/3.2		6.1	44.6 m/4.2		4.0	5.9			44.0 m
	46.0 m		5.7	4.5			5.7	4.3		5.7	4.0	2.8	5.5	46.4 m/3.8				46.0 m
	48.0 m		46.1 m/5.4	4.2			5.3	4.0		5.3	3.8			5.2	3.6			48.0 m
	50.0 m			3.9			49.0 m/4.7	3.7		4.9	3.6			4.8	3.4			50.0 m
	52.0 m			3.6				3.5		4.3	3.3			4.5	3.2			52.0 m
	54.0 m			3.4				3.2			3.1			4.2	3.0			54.0 m
	56.0 m				54.7 m/3.3			3.0			2.9			54.9 m/3.8	2.8			56.0 m
	58.0 m							57.6 m/2.8			2.7				2.6			58.0 m
	60.0 m										2.5				2.4			60.0 m
	62.0 m										60.6 m/2.4				2.2			62.0 m
	64.0 m														63.5 m/2.0			64.0 m
	Reeves	2	2	2	2	2	2	1	1	1	1	1	1	1	1	1	1	Reeves

Note:
 Ratings according to Japanese Construction Codes for Mobile Cranes and Japanese Safety Ordinance on Cranes, etc.
 Ratings shown in [] are determined by the strength of the boom or other structural components.
 Refer to notes P19 and P20.

CLAMSHELL

Clamshell Ratings in metric tons for 360° Working area

Boom Length (m)	A	15.2 m					18.3 m					21.3 m					
Boom angle (°)	θ	36	48	58	66	70	39	48	56	64	70	40	48	55	62	68	
Operating radius (m)	R	14.0	12.0	10.0	8.0	7.0	16.0	14.0	12.0	10.0	8.0	18.0	16.0	14.0	12.0	10.0	
Dumping Height	Bucket capacity	2.0 m ³	H														
		2.5 m ³	4.6	7.0	8.6	9.7	10.1	7.0	9.2	10.9	12.1	13.0	9.4	11.5	13.2	14.5	15.5
		3.0 m ³	4.2	6.6	8.2	9.3	9.7	6.6	8.8	10.5	11.7	12.6	9.0	11.1	12.8	14.1	15.1
		4.0 m ³	4.0	6.4	8.0	9.1	9.5	6.4	8.6	10.3	11.5	12.4	8.8	10.9	12.6	13.9	14.9
Boom point height (m)	h	13.3	15.6	17.2	18.5	19.0	13.3	15.6	17.2	18.5	19.0	15.7	17.9	19.5	20.8	21.8	
Rated load (ton)		10.0															

Boom Length (m)	A	24.4 m					27.4 m						
Boom angle (°)	θ	42	48	54	60	65	42	48	54	59	64	68	
Operating radius (m)	R	20.0	18.0	16.0	14.0	12.0	22.0	20.0	18.0	16.0	14.0	12.0	
Dumping Height	Bucket capacity	2.0 m ³	H										
		2.5 m ³	11.8	13.9	15.5	16.8	17.9	14.1	16.1	17.8	19.2	20.4	21.3
		3.0 m ³	11.4	13.5	15.1	16.4	17.5	13.7	15.7	17.4	18.8	20.0	20.9
		4.0 m ³	11.2	13.3	14.9	16.2	17.3	13.5	15.5	17.2	18.6	19.8	20.7
Boom point height (m)	h	18.1	20.2	21.8	23.2	24.3	20.4	22.5	24.1	25.5	24.3	26.7	
Rated load (ton)		10.0											

Working Ranges

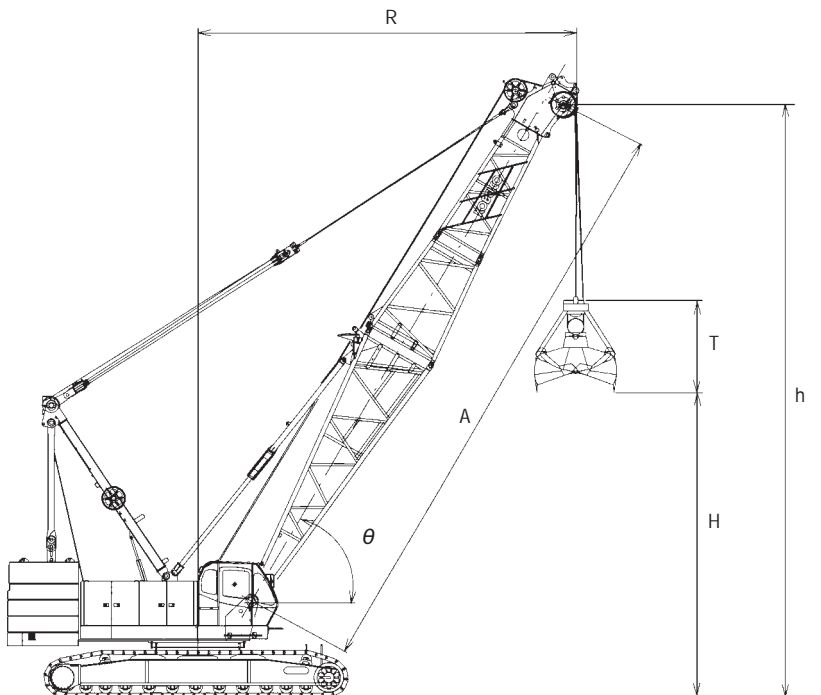

Clamshell Bucket

Bucket capacity (m ³)	Bucket clearance	2.0 m ³	T	3.9 m
		2.5 m ³		4.3 m
		3.0 m ³		4.5 m
		4.0 m ³		4.7 m

Note:

- 1) Bucket unit weight must not exceed 5.5 tons.
- 2) Working radius is the horizontal distance between the center of rotation and the bucket's center of gravity.
- 3) Total weight of bucket and materials must not exceed rated load.
- 4) Optimal bucket should be required according to material.
 $\text{Bucket capacity (m}^3\text{)} \times \text{Specified gravity of material (ton/m}^3\text{)} + \text{Bucket weight (ton)} \leq \text{Rated load}$
 Material: sand, gravel, lime (apparent specific gravity: approx. 1 to 1.5)
 Ex.) Bucket capacity: 3.0 m³, Bucket weight 5.5 tons
 $3.0 \text{ m}^3 \times 1.5 \times 5.5 \text{ tons} = 10.0 \text{ tons}$
- 5) Bucket weight must also be decreased according to operating cycle and bucket lowering height.
- 6) Rated loads are determined by degree of stability. During simultaneous operations of boom and swing, rapid acceleration or deceleration must be avoided. Particular care is required with long boom lengths.

PARTS AND ATTACHMENTS

Base Machine

With gantry, lower boom, carbody, lower spreader and upper spreader
Weight: 36,785 kg Width: 3,200 mm

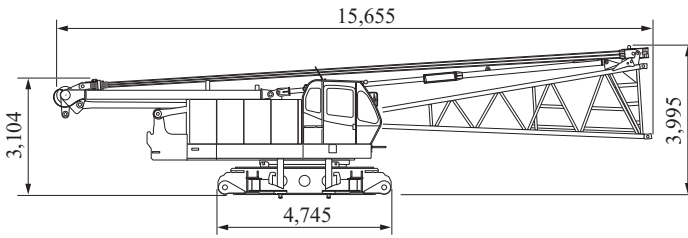

Base Machine

With gantry and carbody
Weight: 33,200 kg Width: 3,200 mm

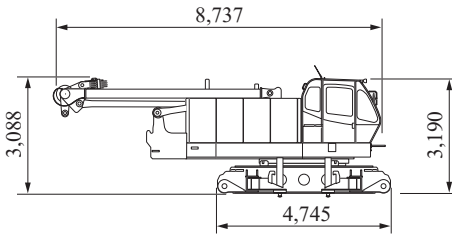

Crawler

Weight: 14,500 kg

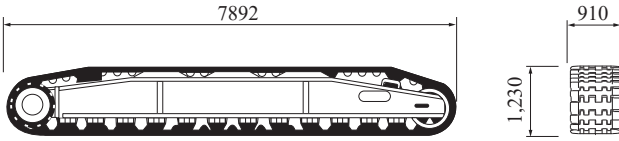

Gantry

Weight: 2,200 kg

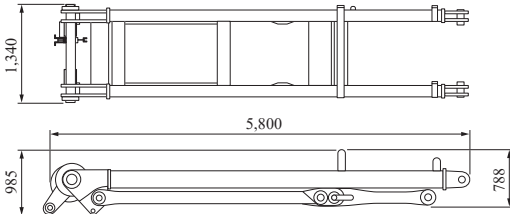

Boom Top

Weight: 1,850 kg

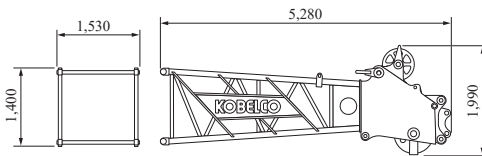

Insert Boom

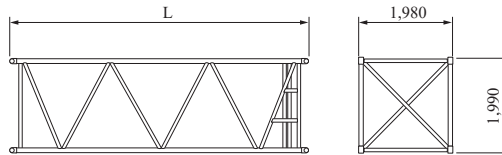

	L (mm)	Weight (kg)*
3.0m	3,180	530
6.1m	6,230	850
9.1m	9,270	1,160

*with guy cables

Boom Base (with tower backstop)

Weight: 3,100 kg

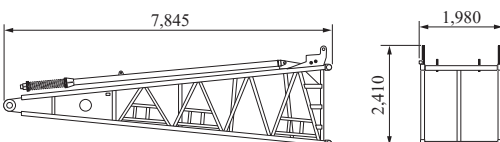

Counterweight A

Weight: 9,900 kg

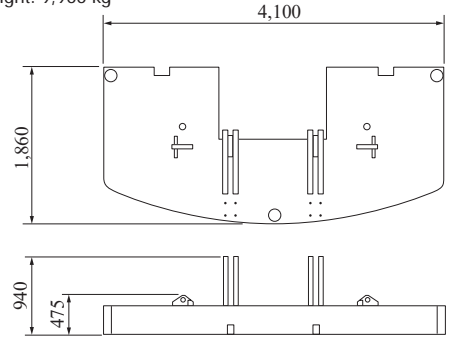

Counterweight B, C

Weight: Counterweight : 10,000 kg x 2 pieces

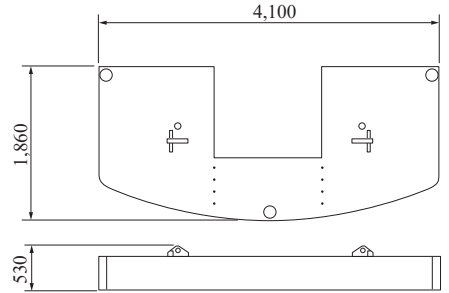

Counterweight D

Weight: Counterweight : 10,000 kg

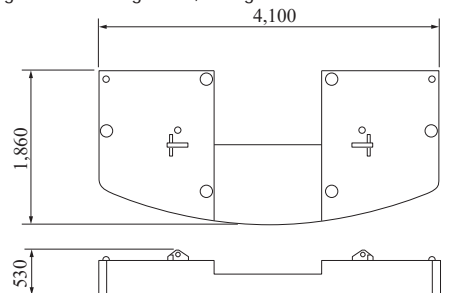

Counterweight E

Weight: 6,300 kg

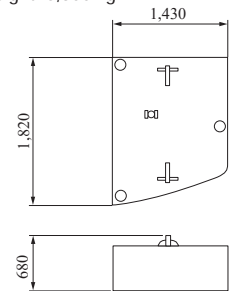

Counterweight F

Weight: 6,100 kg

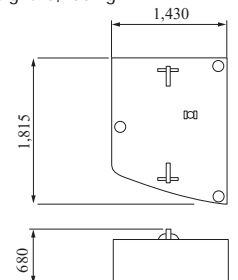

Jib Top (For Crane)

Weight: 315 kg

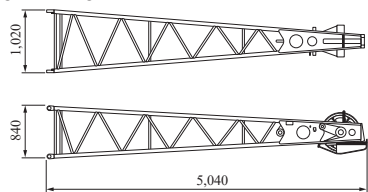

Jib Top (for Luffing Tower)

Weight: 900 kg

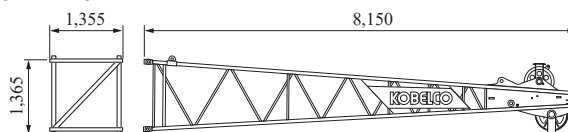

Jib Base (For Crane)

Weight: 210 kg

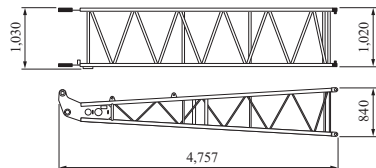

Jib Base (for Luffing Tower)

Weight: 1,200 kg

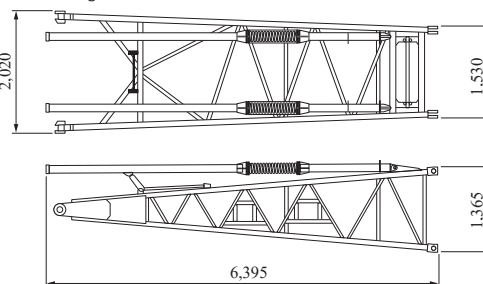

Luffing Tower Cap

Weight: 1,780 kg

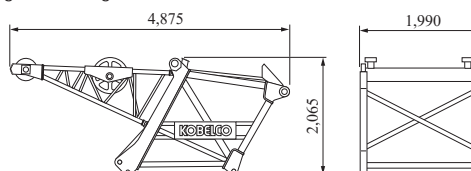

Other Attachments

Attachments	weight	Dimensions (L x W x H)
9.1A special insert boom for tower	1,540 kg	9,270 mm x 1,980 mm x 2,790 mm
3.0 m tapered boom	490 kg	3,180 mm x 1,980 mm x 2,095 mm
3.0A relay jib	230 kg	3,145 mm x 1,530 mm x 1,365 mm
3.0 m tower insert jib	210 kg	3,145 mm x 1,355 mm x 1,365 mm
6.1 m tower insert jib	360 kg	6,195 mm x 1,355 mm x 1,365 mm
9.1 m tower insert jib	510 kg	9,240 mm x 1,355 mm x 1,365 mm
3.0 m insert jib	110 kg	3,130 mm x 1,020 mm x 840 mm
6.1 m insert jib	190 kg	6,175 mm x 1,020 mm x 840 mm
Crane backstop	210 kg (1 pc)	6,265 mm x 115mm dia. x 210 mm
Tower backstop	420 kg (1pc)	6,200 mm x 140 mm dia. x 235 mm
Upper spreader (for crane)	485 kg	2,045 mm x 365 mm x 880 mm
Lower spreader (for crane)	315 kg	1,150 mm x 300 mm x 930 mm
Upper spreader (for luffing tower)	310 kg	925 mm x 730 mm x 1,170 mm
Lower spreader (for luffing tower)	410 kg	1,940 mm x 460 mm x 1,070 mm
Ball hook	450 kg	380 mm dia x 1,200mm
35-ton hook	900 kg	365 mm x 700 mm x 1,575 mm
70-ton hook	1,200 kg	470 mm x 700 mm x 1,825 mm
120-ton hook	1,700 kg	710 mm x 700 mm x 1,930 mm

HYDRAULIC CRAWLER CRANE

7120

Standard Equipment

Upper structure/Lower structure

Counterweight: 52.3 ton (total weight)
910 mm shoe crawlers
Batteries (136AH)
Trans-Lifter
Travel kit
Gantry raising/lowering cylinder
Electric hand throttle grip
Variable boom hoist speed controller
Variable main/aux. hoist speed controller
Swing neutral-free/brake select switch
Side deck for cab
Step (equipped on left-side guard)
Step (equipped on crawlers)
Anti-slip sheet (mounted on the guard)
Two front working lights
Upper spreader storage guide
Tools (for routine maintenance)
Two back mirrors
Mirror for monitoring drums

Cab/Control

Air conditioner
Luggage box
Cup holder
Ashtray
Cigar lighter
Intermittent wiper & window washer
(skylight, front window and lower front window)
Sun visor
Ceiling blind
Tinted glass
Floor mat (cloth)
Foot rest
Shoe tray

Safety Device

Over-load prevention device (w/ boom lowering slow stop function)
Release prevention key for hook over-hoist prevention device
Release prevention key for boom over-hoist prevention device
Multi LCD alarm and gauge display
Second over-hoist prevention device (boom angle limit stop)
Boom over-hoist auto-stop device (slow stop function)
Hook over-hoist auto-stop device
Boom backstops
Safety lever lock (Function lock lever)
Propel lever lock
Manual drum safety pawl (main, aux.)
Manual drum lock (boom hoist)
Neutral negative brakes (main, aux. boom hoist and propel)
Assembly/disassembly mode switch
Lamp for swing neutral-free/brake select switch
Swing neutral-free/brake select switch with lock function
Hydraulically safety valve (main, aux., boom hoist and propel)
Signal horn
Swing brake
Swing lock pin (four-position pin-hole lock)
Swing flashers/warning buzzer

Note: Due to our policy of continual product improvements all designs and specifications are subject to change without advance notice.
Copyright by KOBELCO CRANES CO., LTD. No parts of this catalog may be reproduced in any manner without notice.

KOBELCO CRANES CO., LTD.

17-1, Higashigotanda 2-chome, Shinagawa-ku, Tokyo 141-8626 JAPAN
Tel: +81-3-5789-2130 Fax: +81-3-5789-3372

Inquiries To: